



---

# 2018

## Shuttle Pricebook



| CATEGORY   |   | PAGE                         |
|--|---|------------------------------|
| <b>STUDENT DESKS and<br/>MULTI-PURPOSE TABLES</b><br>(see page 1 for overview)   | Straight Profile (rectangular top)                                      | 2-3                          |
|  | Forum Profile (top has subtle curve)                                    | 4-5                          |
|  | Wave Profile (top has curved front)                                     | 6-7                          |
|  | Corner Profile  | 8-9                          |
|  | Rounded Shapes  | 10-11                        |
|  | Specialty Shapes  | 12                           |
|  | Accessories   | 13                           |
| <b>TEACHER DESKS and<br/>WORKSPACE STORAGE</b><br>(see pages 14-15 for overview) | Open Space Desks and Storage  | 16-19                        |
|  | Latchable Desks and Storage   | 20-23                        |
|  | Single Pedestal Desks   | 24-27                        |
|  | Double Pedestal Desks   | 28-29                        |
|  | Techera Teacher Workstation   | 30-31                        |
|  | Accessories   | 32                           |
| <b>MOBILE STORAGE</b><br>(see pages 34-35 for overview)                          | Mobile Cabinets   | 36-37                        |
|  | Mobile Wardrobes  | 38-39                        |
|  | Mobile Workspace / Storage  | 40-41                        |
|  | Mobile Cubbies  | 42                           |
|  | Stationary Storage Cabinets   | 43                           |
|  | Accessories   | 44                           |
|  | <b>SHUTTLEMATE<br/>COMPUTER DESKS</b><br>(see pages 46-47 for overview) | ShuttleMate Straight Profile |
| ShuttleMate Wave Profile   |   | 49                           |
| Corner Stations  |   | 50                           |
| Accessories  |   | 51                           |
| <b>SHUTTLESYSTEM<br/>COMPUTER STATIONS</b><br>(see pages 52-53 for overview)     | Computer Desks  | 54                           |
|  | Accessories   | 55                           |
| <b>STARTER / ADDER DESKS</b><br>(see pages 56-57 for overview)                   | Tandem  | 58-59                        |
|  | Navetta Fixed Tables  | 60                           |
|  | Auditorium Seating  | 61                           |
|  | Navetta Loose Chairs/Furniture  | 62 -63                       |
|  | Tandem Accessories  | 64 - 65                      |

# ShuttleZone

## Changeable Desks & Tables



The most versatile tables ever designed for schools, ShuttleZone Changeable Desks and Tables transform ordinary classrooms into changeable, technology-friendly learning spaces.









Student Desks &  
Classroom Tables

MultiPurpose  
Tables

- Rugged 14-gauge steel legs in your choice of styles
- Metal-to-metal connections and triple-arc welds
- Premium PVC edging
- Contemporary design and high-performance features
- Hundreds of shapes and sizes

# ShuttleZone Changeable Desks & Tables

## INDEX

| CATEGORY   | PAGE                        |
|--|-----------------------------|
| <b>Student Desks &amp; MultiPurpose Tables</b>                                     |                             |
|   | Straight Profile            |
|   | Forum Profile               |
|   | Wave Profile                |
|   | Corner Profile              |
|   | Modular Rounded Shapes      |
|  | Specialty Shapes            |
| <b>Accessories</b>   |                             |
|  | Mobile Pedestals            |
|  | Storage Totes               |
|  | Book Boxes & Center Drawers |
|  | Technology Accessories      |

### Shipping of ShuttleZone Changeable Desks & Tables





- > All orders of 10 stations and over will be bulk packed on pallets.
- > Orders under 10 stations may be individually cartoned (large components may also be palletized).
- > Weights are approximate and include shipping cartons.
- > Freight classification is 70 for disassembled flat product.

## ◁ STRAIGHT PROFILE SHAPE 20"D / 24"D / 30"D

### ① CHOOSE SIZE

### ② SELECT LEG STYLE for base model number and base price

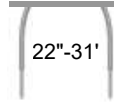
| Width                       | Depth |
|-----------------------------|-------|
| <b>26" Straight Profile</b> | 20" D |
|                             | 24" D |
|                             | 30" D |
| <b>30" Straight Profile</b> | 20" D |
|                             | 24" D |
|                             | 30" D |
| <b>36" Straight Profile</b> | 20" D |
|                             | 24" D |
|                             | 30" D |
| <b>42" Straight Profile</b> | 20" D |
|                             | 24" D |
|                             | 30" D |
| <b>48" Straight Profile</b> | 20" D |
|                             | 24" D |
|                             | 30" D |
| <b>54" Straight Profile</b> | 20" D |
|                             | 24" D |
|                             | 30" D |
| <b>60" Straight Profile</b> | 20" D |
|                             | 24" D |
|                             | 30" D |
| <b>72" Straight Profile</b> | 20" D |
|                             | 24" D |
|                             | 30" D |

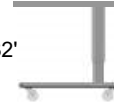
| Fixed Arc Leg   |   | Adjustable Arc Leg  |   | Adjustable Pedestal Leg   |         |
|---|---|---|---|---|---------|
|  |  |  |  |  |         |
| 29"   |   | 22"-31'   |   | 22" - 32'   |         |
| Glides  | Casters   | Glides  | Glides  | Casters   | Casters |
| SZFT-FG-ST2026  | SZFT-FC-ST2026  | SZFT-AG-ST2026  | Special Order   |   |         |
| \$249   | \$309   | \$265   |   |   |         |
| SZFT-FG-ST2426  | SZFT-FC-ST2426  | SZFT-AG-ST2426  | SZFT-HG-ST2426  | SZFT-HC-ST2426  |         |
| \$385   | \$459   | \$434   | \$585   | \$679   |         |
| SZFT-FG-ST3026  | SZFT-FC-ST3026  | SZFT-AG-ST3026  | SZFT-HG-ST3026  | SZFT-HC-ST3026  |         |
| \$382   | \$467   | \$443   | \$605   | \$699   |         |
| SZFT-FG-ST2030  | SZFT-FC-ST2030  | SZFT-AG-ST2030  | Special Order   |   |         |
| \$345   | \$419   | \$396   |   |   |         |
| SZFT-FG-ST2430  | SZFT-FC-ST2430  | SZFT-AG-ST2430  | SZFT-HG-ST2430  | SZFT-HC-ST2430  |         |
| \$404   | \$475   | \$450   | \$596   | \$684   |         |
| SZFT-FG-ST3030  | SZFT-FC-ST3030  | SZFT-AG-ST3030  | SZFT-HG-ST3030  | SZFT-HC-ST3030  |         |
| \$421   | \$495   | \$472   | \$605   | \$699   |         |
| SZFT-FG-ST2036  | SZFT-FC-ST2036  | SZFT-AG-ST2036  | Special Order   |   |         |
| \$366   | \$439   | \$415   |   |   |         |
| SZFT-FG-ST2436  | SZFT-FC-ST2436  | SZFT-AG-ST2436  | SZFT-HG-ST2436  | SZFT-HC-ST2436  |         |
| \$420   | \$493   | \$469   | \$605   | \$699   |         |
| SZFT-FG-ST3036  | SZFT-FC-ST3036  | SZFT-AG-ST3036  | SZFT-HG-ST3036  | SZFT-HC-ST3036  |         |
| \$440   | \$513   | \$490   | \$623   | \$717   |         |
| SZFT-FG-ST2042  | SZFT-FC-ST2042  | SZFT-AG-ST2042  | Special Order   |   |         |
| \$392   | \$467   | \$443   |   |   |         |
| SZFT-FG-ST2442  | SZFT-FC-ST2442  | SZFT-AG-ST2442  | SZFT-HG-ST2442  | SZFT-HC-ST2442  |         |
| \$439   | \$513   | \$488   | \$630   | \$719   |         |
| SZFT-FG-ST3042  | SZFT-FC-ST3042  | SZFT-AG-ST3042  | SZFT-HG-ST3042  | SZFT-HC-ST3042  |         |
| \$455   | \$526   | \$504   | \$646   | \$737   |         |
| SZFT-FG-ST2048  | SZFT-FC-ST2048  | SZFT-AG-ST2048  | Special Order   |   |         |
| \$420   | \$493   | \$469   |   |   |         |
| SZFT-FG-ST2448  | SZFT-FC-ST2448  | SZFT-AG-ST2448  | SZFT-HG-ST2448  | SZFT-HC-ST2448  |         |
| \$459   | \$529   | \$505   | \$646   | \$738   |         |
| SZFT-FG-ST3048  | SZFT-FC-ST3048  | SZFT-AG-ST3048  | SZFT-HG-ST3048  | SZFT-HC-ST3048  |         |
| \$474   | \$548   | \$524   | \$662   | \$756   |         |
| SZFT-FG-ST2054  | SZFT-FC-ST2054  | SZFT-AG-ST2054  | Special Order   |   |         |
| \$445   | \$520   | \$497   |   |   |         |
| SZFT-FG-ST2454  | SZFT-FC-ST2454  | SZFT-AG-ST2454  | SZFT-HG-ST2454  | SZFT-HC-ST2454  |         |
| \$472   | \$545   | \$521   | \$666   | \$759   |         |
| SZFT-FG-ST3054  | SZFT-FC-ST3054  | SZFT-AG-ST3054  | SZFT-HG-ST3054  | SZFT-HC-ST3054  |         |
| \$488   | \$559   | \$539   | \$681   | \$774   |         |
| SZFT-FG-ST2060  | SZFT-FC-ST2060  | SZFT-AG-ST2060  | Special Order   |   |         |
| \$510   | \$583   | \$558   |   |   |         |
| SZFT-FG-ST2460  | SZFT-FC-ST2460  | SZFT-AG-ST2460  | SZFT-HG-ST2460  | SZFT-HC-ST2460  |         |
| \$519   | \$592   | \$567   | \$692   | \$785   |         |
| SZFT-FG-ST3060  | SZFT-FC-ST3060  | SZFT-AG-ST3060  | SZFT-HG-ST3060  | SZFT-HC-ST3060  |         |
| \$525   | \$598   | \$576   | \$700   | \$792   |         |
| SZFT-FG-ST2072  | SZFT-FC-ST2072  | SZFT-AG-ST2072  | Special Order   |   |         |
| \$571   | \$643   | \$620   |   |   |         |
| SZFT-FG-ST2472  | SZFT-FC-ST2472  | SZFT-AG-ST2472  | SZFT-HG-ST2472  | SZFT-HC-ST2472  |         |
| \$588   | \$660   | \$639   | \$769   | \$856   |         |
| SZFT-FG-ST3072  | SZFT-FC-ST3072  | SZFT-AG-ST3072  | SZFT-HG-ST3072  | SZFT-HC-ST3072  |         |
| \$609   | \$680   | \$657   | \$788   | \$876   |         |



**③ ADD OPTION CODES and PRICES**

Add an Option Code for each category to base Model Number.  
Add the price for each selected Option to base price.

| Top Cutout  | ShuttleLatch                                      | Wire Tray   |
|---|---|---|
| <p><b>-X</b><br/>No cutout<br/><b>N/C</b></p>                                 | <p><b>-X</b><br/>No Latch<br/><b>N/C</b></p>      | <p><b>-X</b><br/>No Modesty Tray<br/><b>N/C</b></p>   |
| <p><b>-G</b><br/>One 3" Grommet<br/><b>\$32</b></p>                           | <p><b>-L</b><br/>ShuttleLatch<br/><b>\$58</b></p> | <p><b>-M</b><br/>12" Modesty Height<br/>Wire Manager<br/>(stations 36" or wider)<br/><b>\$186</b></p> |
| <p><b>-2</b><br/>Two Grommets<br/>(stations 48" or wider)<br/><b>\$64</b></p> |   |   |
| <p><b>-E</b><br/>MiniPort<br/><b>\$294</b></p>                                |   |   |

**EXAMPLE**

- ① 24 x 60 Straight Profile ShuttleZone Table
- ② on Fixed Arc Legs with Glides and...
- ③ one grommet, ShuttleLatch, no wire tray

| MODEL NUMBER   |              |
|----------------|--------------|
| Model Number   | Option Codes |
| SZFT-FG-ST2460 | - G - L - X  |

| PRODUCT PRICE       |                   |
|---------------------|-------------------|
| Base Price          | Option Prices     |
| \$519               | + \$32 + \$58 + 0 |
| <b>Total Price:</b> |                   |
| \$609               |                   |

**WORKSHEET**

| MODEL NUMBER |              |
|--------------|--------------|
| Model Number | Option Codes |
| _____        | - - - -      |

| PRODUCT PRICE       |                         |
|---------------------|-------------------------|
| Base Price          | Option Prices           |
| \$ _____            | + _____ + _____ + _____ |
| <b>Total Price:</b> |                         |
| \$ _____            |                         |

Please contact your ShuttleSystem dealer to obtain discounted project pricing.

| Available Accessories: | see page |
|------------------------|----------|
| Book Boxes             | 13       |
| Power / Data MiniPort  | 13       |
| Keyboard Tray          | 13       |

◁ **FORUM PROFILE SHAPE** 20"D / 24"D / 30"D



① **CHOOSE SIZE**

② **SELECT LEG STYLE** for base model number and base price

| Width                    | Depth |
|--------------------------|-------|
| <b>26" Forum Profile</b> | 20" D |
|                          | 24" D |
|                          | 30" D |
| <b>30" Forum Profile</b> | 20" D |
|                          | 24" D |
|                          | 30" D |
| <b>36" Forum Profile</b> | 20" D |
|                          | 24" D |
|                          | 30" D |
| <b>42" Forum Profile</b> | 20" D |
|                          | 24" D |
|                          | 30" D |
| <b>48" Forum Profile</b> | 20" D |
|                          | 24" D |
|                          | 30" D |
| <b>54" Forum Profile</b> | 20" D |
|                          | 24" D |
|                          | 30" D |
| <b>60" Forum Profile</b> | 20" D |
|                          | 24" D |
|                          | 30" D |

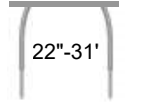
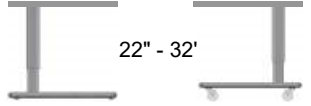
| Fixed Arc Leg   |                | Adjustable Arc Leg  |  | Adjustable Pedestal Leg   |                |
|---|----------------|---|--|---|----------------|
|  |                |  |  |  |                |
| 29"   |                | 22"-31'   |  | 22" - 32'   |                |
| Glides  | Casters        | Glides  |  | Glides  | Casters        |
| Special Order   |                |   |  |   |                |
| SZFT-FG-FM2026  | SZFT-FC-FM2026 | SZFT-AG-FM2026  |  | SZFT-HG-FM2426  | SZFT-HC-FM2426 |
| <b>\$249</b>  | <b>\$309</b>   | <b>\$265</b>  |  | <b>\$585</b>  | <b>\$679</b>   |
| SZFT-FG-FM2426  | SZFT-FC-FM2426 | SZFT-AG-FM2426  |  | SZFT-HG-FM3026  | SZFT-HC-FM3026 |
| <b>\$385</b>  | <b>\$459</b>   | <b>\$434</b>  |  | <b>\$605</b>  | <b>\$699</b>   |
| SZFT-FG-FM3026  | SZFT-FC-FM3026 | SZFT-AG-FM3026  |  | Special Order   |                |
| <b>\$382</b>  | <b>\$467</b>   | <b>\$443</b>  |  | Special Order   |                |
| SZFT-FG-FM2030  | SZFT-FC-FM2030 | SZFT-AG-FM2030  |  | SZFT-HG-FM2430  | SZFT-HC-FM2430 |
| <b>\$345</b>  | <b>\$419</b>   | <b>\$396</b>  |  | <b>\$596</b>  | <b>\$684</b>   |
| SZFT-FG-FM2430  | SZFT-FC-FM2430 | SZFT-AG-FM2430  |  | SZFT-HG-FM3030  | SZFT-HC-FM3030 |
| <b>\$404</b>  | <b>\$475</b>   | <b>\$450</b>  |  | <b>\$605</b>  | <b>\$699</b>   |
| SZFT-FG-FM3030  | SZFT-FC-FM3030 | SZFT-AG-FM3030  |  | Special Order   |                |
| <b>\$421</b>  | <b>\$495</b>   | <b>\$472</b>  |  | Special Order   |                |
| SZFT-FG-FM2036  | SZFT-FC-FM2036 | SZFT-AG-FM2036  |  | SZFT-HG-FM2436  | SZFT-HC-FM2436 |
| <b>\$366</b>  | <b>\$439</b>   | <b>\$415</b>  |  | <b>\$605</b>  | <b>\$699</b>   |
| SZFT-FG-FM2436  | SZFT-FC-FM2436 | SZFT-AG-FM2436  |  | SZFT-HG-FM3036  | SZFT-HC-FM3036 |
| <b>\$420</b>  | <b>\$493</b>   | <b>\$469</b>  |  | <b>\$623</b>  | <b>\$717</b>   |
| SZFT-FG-FM3036  | SZFT-FC-FM3036 | SZFT-AG-FM3036  |  | Special Order   |                |
| <b>\$440</b>  | <b>\$513</b>   | <b>\$490</b>  |  | Special Order   |                |
| SZFT-FG-FM2042  | SZFT-FC-FM2042 | SZFT-AG-FM2042  |  | SZFT-HG-FM2442  | SZFT-HC-FM2442 |
| <b>\$392</b>  | <b>\$467</b>   | <b>\$443</b>  |  | <b>\$630</b>  | <b>\$719</b>   |
| SZFT-FG-FM2442  | SZFT-FC-FM2442 | SZFT-AG-FM2442  |  | SZFT-HG-FM3042  | SZFT-HC-FM3042 |
| <b>\$439</b>  | <b>\$513</b>   | <b>\$488</b>  |  | <b>\$646</b>  | <b>\$737</b>   |
| SZFT-FG-FM3042  | SZFT-FC-FM3042 | SZFT-AG-FM3042  |  | Special Order   |                |
| <b>\$455</b>  | <b>\$526</b>   | <b>\$504</b>  |  | Special Order   |                |
| SZFT-FG-FM2048  | SZFT-FC-FM2048 | SZFT-AG-FM2048  |  | SZFT-HG-FM2448  | SZFT-HC-FM2448 |
| <b>\$420</b>  | <b>\$493</b>   | <b>\$469</b>  |  | <b>\$646</b>  | <b>\$738</b>   |
| SZFT-FG-FM2448  | SZFT-FC-FM2448 | SZFT-AG-FM2448  |  | SZFT-HG-FM3048  | SZFT-HC-FM3048 |
| <b>\$459</b>  | <b>\$529</b>   | <b>\$505</b>  |  | <b>\$662</b>  | <b>\$756</b>   |
| SZFT-FG-FM3048  | SZFT-FC-FM3048 | SZFT-AG-FM3048  |  | Special Order   |                |
| <b>\$474</b>  | <b>\$548</b>   | <b>\$524</b>  |  | Special Order   |                |
| SZFT-FG-FM2054  | SZFT-FC-FM2054 | SZFT-AG-FM2054  |  | SZFT-HG-FM2454  | SZFT-HC-FM2454 |
| <b>\$445</b>  | <b>\$520</b>   | <b>\$497</b>  |  | <b>\$666</b>  | <b>\$759</b>   |
| SZFT-FG-FM2454  | SZFT-FC-FM2454 | SZFT-AG-FM2454  |  | SZFT-HG-FM3054  | SZFT-HC-FM3054 |
| <b>\$472</b>  | <b>\$545</b>   | <b>\$521</b>  |  | <b>\$681</b>  | <b>\$774</b>   |
| SZFT-FG-FM3054  | SZFT-FC-FM3054 | SZFT-AG-FM3054  |  | Special Order   |                |
| <b>\$488</b>  | <b>\$559</b>   | <b>\$539</b>  |  | Special Order   |                |
| SZFT-FG-FM2060  | SZFT-FC-FM2060 | SZFT-AG-FM2060  |  | SZFT-HG-FM2460  | SZFT-HC-FM2460 |
| <b>\$510</b>  | <b>\$583</b>   | <b>\$558</b>  |  | <b>\$692</b>  | <b>\$785</b>   |
| SZFT-FG-FM2460  | SZFT-FC-FM2460 | SZFT-AG-FM2460  |  | SZFT-HG-FM3060  | SZFT-HC-FM3060 |
| <b>\$519</b>  | <b>\$592</b>   | <b>\$567</b>  |  | <b>\$700</b>  | <b>\$792</b>   |
| SZFT-FG-FM3060  | SZFT-FC-FM3060 | SZFT-AG-FM3060  |  | Special Order   |                |
| <b>\$525</b>  | <b>\$598</b>   | <b>\$576</b>  |  | Special Order   |                |





**③ ADD OPTION CODES and PRICES**

Add an Option Code for each category to base Model Number.

Add the price for each selected Option to base price.

| Top Cutout  | ShuttleLatch                                      | Wire Tray   |
|---|---|---|
| <p><b>-X</b><br/>No cutout<br/><b>N/C</b></p>                                 | <p><b>-X</b><br/>No Latch<br/><b>N/C</b></p>      | <p><b>-X</b><br/>No Modesty Tray<br/><b>N/C</b></p>   |
| <p><b>-G</b><br/>One 3" Grommet<br/><b>\$32</b></p>                           | <p><b>-L</b><br/>ShuttleLatch<br/><b>\$58</b></p> | <p><b>-M</b><br/>12" Modesty Height<br/>Wire Manager<br/>(stations 36" or wider)<br/><b>\$186</b></p> |
| <p><b>-2</b><br/>Two Grommets<br/>(stations 48" or wider)<br/><b>\$64</b></p> |   |   |
| <p><b>-E</b><br/>MiniPort<br/><b>\$294</b></p>                                |   |   |

**EXAMPLE**

- ① 24 x 60 Forum Profile ShuttleZone Table
- ② on Fixed Arc Legs with Glides and...
- ③ one grommet, ShuttleLatch, no wire tray

**MODEL NUMBER**

| Model Number   | Option Codes |
|----------------|--------------|
| SZFT-FG-FM2460 | - G - L - X  |

**PRODUCT PRICE**

| Base Price          | Option Prices     |
|---------------------|-------------------|
| \$519               | + \$32 + \$58 + 0 |
| <b>Total Price:</b> |                   |
| \$609               |                   |

**WORKSHEET**

**MODEL NUMBER**

| Model Number | Option Codes |
|--------------|--------------|
|              | - - -        |

**PRODUCT PRICE**

| Base Price          | Option Prices |
|---------------------|---------------|
| \$                  | + + +         |
| <b>Total Price:</b> |               |
| \$                  |               |

Please contact your ShuttleSystem dealer to obtain discounted project pricing.

| Available Accessories:  | see page |
|-------------------------|----------|
| • Book Boxes            | 13       |
| • Power / Data MiniPort | 13       |
| • Keyboard Tray         | 13       |

◁ **WAVE PROFILE SHAPE** 20"D / 24"D / 30"D

**① CHOOSE SIZE**

**② SELECT LEG STYLE for base model number and base price**

| Width                   | Depth |
|-------------------------|-------|
| <b>26" Wave Profile</b> | 20" D |
|                         | 24" D |
|                         | 30" D |
| <b>30" Wave Profile</b> | 20" D |
|                         | 24" D |
|                         | 30" D |
| <b>36" Wave Profile</b> | 20" D |
|                         | 24" D |
|                         | 30" D |
| <b>42" Wave Profile</b> | 20" D |
|                         | 24" D |
|                         | 30" D |
| <b>48" Wave Profile</b> | 20" D |
|                         | 24" D |
|                         | 30" D |
| <b>54" Wave Profile</b> | 20" D |
|                         | 24" D |
|                         | 30" D |
| <b>60" Wave Profile</b> | 20" D |
|                         | 24" D |
|                         | 30" D |
| <b>72" Wave Profile</b> | 20" D |
|                         | 24" D |
|                         | 30" D |

| Fixed Arc Leg  |                | Adjustable Arc Leg |  | Adjustable Pedestal Leg |                |
|----------------|----------------|--------------------|--|-------------------------|----------------|
| 29"            |                | 22"-31'            |  | 22" - 32'               |                |
| Glides         | Casters        | Glides             |  | Glides                  | Casters        |
| SZFT-FG-WV2026 | SZFT-FC-WV2026 | SZFT-AG-WV2026     |  | Special Order           |                |
| <b>\$249</b>   | <b>\$309</b>   | <b>\$265</b>       |  |                         |                |
| SZFT-FG-WV2426 | SZFT-FC-WV2426 | SZFT-AG-WV2426     |  | SZFT-HG-WV2426          | SZFT-HC-WV2426 |
| <b>\$385</b>   | <b>\$459</b>   | <b>\$434</b>       |  | <b>\$585</b>            | <b>\$679</b>   |
| SZFT-FG-WV3026 | SZFT-FC-WV3026 | SZFT-AG-WV3026     |  | SZFT-HG-WV3026          | SZFT-HC-WV3026 |
| <b>\$382</b>   | <b>\$467</b>   | <b>\$443</b>       |  | <b>\$605</b>            | <b>\$699</b>   |
| SZFT-FG-WV2030 | SZFT-FC-WV2030 | SZFT-AG-WV2030     |  | Special Order           |                |
| <b>\$345</b>   | <b>\$419</b>   | <b>\$396</b>       |  |                         |                |
| SZFT-FG-WV2430 | SZFT-FC-WV2430 | SZFT-AG-WV2430     |  | SZFT-HG-WV2430          | SZFT-HC-WV2430 |
| <b>\$404</b>   | <b>\$475</b>   | <b>\$450</b>       |  | <b>\$596</b>            | <b>\$684</b>   |
| SZFT-FG-WV3030 | SZFT-FC-WV3030 | SZFT-AG-WV3030     |  | SZFT-HG-WV3030          | SZFT-HC-WV3030 |
| <b>\$421</b>   | <b>\$495</b>   | <b>\$472</b>       |  | <b>\$605</b>            | <b>\$699</b>   |
| SZFT-FG-WV2036 | SZFT-FC-WV2036 | SZFT-AG-WV2036     |  | Special Order           |                |
| <b>\$366</b>   | <b>\$439</b>   | <b>\$415</b>       |  |                         |                |
| SZFT-FG-WV2436 | SZFT-FC-WV2436 | SZFT-AG-WV2436     |  | SZFT-HG-WV2436          | SZFT-HC-WV2436 |
| <b>\$420</b>   | <b>\$493</b>   | <b>\$469</b>       |  | <b>\$605</b>            | <b>\$699</b>   |
| SZFT-FG-WV3036 | SZFT-FC-WV3036 | SZFT-AG-WV3036     |  | SZFT-HG-WV3036          | SZFT-HC-WV3036 |
| <b>\$440</b>   | <b>\$513</b>   | <b>\$490</b>       |  | <b>\$623</b>            | <b>\$717</b>   |
| SZFT-FG-WV2042 | SZFT-FC-WV2042 | SZFT-AG-WV2042     |  | Special Order           |                |
| <b>\$392</b>   | <b>\$467</b>   | <b>\$443</b>       |  |                         |                |
| SZFT-FG-WV2442 | SZFT-FC-WV2442 | SZFT-AG-WV2442     |  | SZFT-HG-WV2442          | SZFT-HC-WV2442 |
| <b>\$439</b>   | <b>\$513</b>   | <b>\$488</b>       |  | <b>\$630</b>            | <b>\$719</b>   |
| SZFT-FG-WV3042 | SZFT-FC-WV3042 | SZFT-AG-WV3042     |  | SZFT-HG-WV3042          | SZFT-HC-WV3042 |
| <b>\$455</b>   | <b>\$526</b>   | <b>\$504</b>       |  | <b>\$646</b>            | <b>\$737</b>   |
| SZFT-FG-WV2048 | SZFT-FC-WV2048 | SZFT-AG-WV2048     |  | Special Order           |                |
| <b>\$420</b>   | <b>\$493</b>   | <b>\$469</b>       |  |                         |                |
| SZFT-FG-WV2448 | SZFT-FC-WV2448 | SZFT-AG-WV2448     |  | SZFT-HG-WV2448          | SZFT-HC-WV2448 |
| <b>\$459</b>   | <b>\$529</b>   | <b>\$505</b>       |  | <b>\$646</b>            | <b>\$738</b>   |
| SZFT-FG-WV3048 | SZFT-FC-WV3048 | SZFT-AG-WV3048     |  | SZFT-HG-WV3048          | SZFT-HC-WV3048 |
| <b>\$474</b>   | <b>\$548</b>   | <b>\$524</b>       |  | <b>\$662</b>            | <b>\$756</b>   |
| SZFT-FG-WV2054 | SZFT-FC-WV2054 | SZFT-AG-WV2054     |  | Special Order           |                |
| <b>\$445</b>   | <b>\$520</b>   | <b>\$497</b>       |  |                         |                |
| SZFT-FG-WV2454 | SZFT-FC-WV2454 | SZFT-AG-WV2454     |  | SZFT-HG-WV2454          | SZFT-HC-WV2454 |
| <b>\$472</b>   | <b>\$545</b>   | <b>\$521</b>       |  | <b>\$666</b>            | <b>\$759</b>   |
| SZFT-FG-WV3054 | SZFT-FC-WV3054 | SZFT-AG-WV3054     |  | SZFT-HG-WV3054          | SZFT-HC-WV3054 |
| <b>\$488</b>   | <b>\$559</b>   | <b>\$539</b>       |  | <b>\$681</b>            | <b>\$774</b>   |
| SZFT-FG-WV2060 | SZFT-FC-WV2060 | SZFT-AG-WV2060     |  | Special Order           |                |
| <b>\$510</b>   | <b>\$583</b>   | <b>\$558</b>       |  |                         |                |
| SZFT-FG-WV2460 | SZFT-FC-WV2460 | SZFT-AG-WV2460     |  | SZFT-HG-WV2460          | SZFT-HC-WV2460 |
| <b>\$519</b>   | <b>\$592</b>   | <b>\$567</b>       |  | <b>\$692</b>            | <b>\$785</b>   |
| SZFT-FG-WV3060 | SZFT-FC-WV3060 | SZFT-AG-WV3060     |  | SZFT-HG-WV3060          | SZFT-HC-WV3060 |
| <b>\$525</b>   | <b>\$598</b>   | <b>\$576</b>       |  | <b>\$700</b>            | <b>\$792</b>   |
| SZFT-FG-WV2072 | SZFT-FC-WV2072 | SZFT-AG-WV2072     |  | Special Order           |                |
| <b>\$571</b>   | <b>\$643</b>   | <b>\$620</b>       |  |                         |                |
| SZFT-FG-WV2472 | SZFT-FC-WV2472 | SZFT-AG-WV2472     |  | SZFT-HG-WV2472          | SZFT-HC-WV2472 |
| <b>\$588</b>   | <b>\$660</b>   | <b>\$639</b>       |  | <b>\$769</b>            | <b>\$856</b>   |
| SZFT-FG-WV3072 | SZFT-FC-WV3072 | SZFT-AG-WV3072     |  | SZFT-HG-WV3072          | SZFT-HC-WV3072 |
| <b>\$609</b>   | <b>\$680</b>   | <b>\$657</b>       |  | <b>\$788</b>            | <b>\$876</b>   |



**③ ADD OPTION CODES and PRICES**

Add an Option Code for each category to base Model Number.  
 Add the price for each selected Option to base price.

| Top Cutout  | ShuttleLatch                                      | Wire Tray   |
|---|---|---|
| <p><b>-X</b><br/>No cutout<br/><b>N/C</b></p>                                 | <p><b>-X</b><br/>No Latch<br/><b>N/C</b></p>      | <p><b>-X</b><br/>No Modesty Tray<br/><b>N/C</b></p>   |
| <p><b>-G</b><br/>One 3" Grommet<br/><b>\$32</b></p>                           | <p><b>-L</b><br/>Shuttlelatch<br/><b>\$58</b></p> | <p><b>-M</b><br/>12" Modesty Height<br/>Wire Manager<br/>(stations 36" or wider)<br/><b>\$186</b></p> |
| <p><b>-2</b><br/>Two Grommets<br/>(stations 48" or wider)<br/><b>\$64</b></p> |   |   |
| <p><b>-E</b><br/>MiniPort<br/><b>\$294</b></p>                                |   |   |

**EXAMPLE**

- ① 24 x 60 Wave Profile ShuttleZone Table
- ② on Fixed Arc Legs with Glides and...
- ③ one grommet, ShuttleLatch, no wire tray

| MODEL NUMBER   |              |
|----------------|--------------|
| Model Number   | Option Codes |
| SZFT-FG-WV2460 | - G - L - X  |

| PRODUCT PRICE       |                   |
|---------------------|-------------------|
| Base Price          | Option Prices     |
| \$519               | + \$32 + \$58 + 0 |
| <b>Total Price:</b> |                   |
| \$609               |                   |

**WORKSHEET**

| MODEL NUMBER |                      |
|--------------|----------------------|
| Model Number | Option Codes         |
| _____        | - ____ - ____ - ____ |



  

| PRODUCT PRICE       |                      |
|---------------------|----------------------|
| Base Price          | Option Prices        |
| \$ _____            | + ____ + ____ + ____ |
| <b>Total Price:</b> |                      |
| \$ _____            |                      |

Please contact your ShuttleSystem dealer to obtain discounted project pricing.

| Available Accessories: | see page |
|------------------------|----------|
| Book Boxes             | 13       |
| Power / Data MiniPort  | 13       |
| Keyboard Tray          | 13       |

## CORNER PROFILE SHAPE

| ① CHOOSE SIZE  |       | ② SELECT LEG STYLE for base model number and base price |                |                    |
|--|-------|---|----------------|--------------------|
|  |       | Fixed Arc Leg   |                | Adjustable Arc Leg |
|  |       | 29"   |                | 22"-31"            |
| Size   |       | Glides  | Casters        | Glides             |
| <b>Corner Profile</b><br>24" Modular Depth                                       |       |   |                |                    |
|  | 42" D | SZFT-FG-CN2442  | SZFT-FC-CN2442 | SZFT-AG-CN2442     |
|  | 42" W | <b>\$498</b>  | <b>\$575</b>   | <b>\$550</b>       |
|  | 48" D | SZFT-FG-CN2448  | SZFT-FC-CN2448 | SZFT-AG-CN2448     |
|  | 48" W | <b>\$538</b>  | <b>\$611</b>   | <b>\$588</b>       |
| <b>Corner Profile</b><br>30" Modular Depth                                       |       |   |                |                    |
|  | 42" D | SZFT-FG-CN3042  | SZFT-FC-CN3042 | SZFT-AG-CN3042     |
|  | 42" W | <b>\$538</b>  | <b>\$611</b>   | <b>\$588</b>       |
|  | 48" D | SZFT-FG-CN3048  | SZFT-FC-CN3048 | SZFT-AG-CN3048     |
|  | 48" W | <b>\$575</b>  | <b>\$647</b>   | <b>\$622</b>       |

### USING CORNER PROFILE SHAPES

#### Corner Profile Groupings

Combine with other modular shapes to make L-shaped workspaces, perpendicular rows, peninsulas or pods.





**③ ADD OPTION CODES and PRICES**

Add an Option Code for each category to base Model Number.  
Add the price for each selected Option to base price.

| Top Cutout  | ShuttleLatch                                      | Wire Tray   |
|---|---|---|
| <p><b>-X</b><br/>No cutout<br/><b>N/C</b></p>       | <p><b>-X</b><br/>No Latch<br/><b>N/C</b></p>      | <p><b>-X</b><br/>No Modesty Tray<br/><b>N/C</b></p>                       |
| <p><b>-G</b><br/>One 3" Grommet<br/><b>\$32</b></p> | <p><b>-L</b><br/>Shuttlelatch<br/><b>\$58</b></p> | <p><b>-M</b><br/>12" Modesty Height<br/>Wire Manager<br/><b>\$186</b></p> |
| <p><b>-2</b><br/>Two Grommets<br/><b>\$64</b></p>   |   |   |
| <p><b>-E</b><br/>MiniPort<br/><b>\$294</b></p>      |   |   |

**EXAMPLE**

- ① 42" Corner Profile (24" Modular)
- ② on Fixed Arc Legs with Glides and...
- ③ one grommet, ShuttleLatch, no wire tray

**MODEL NUMBER**

| Model Number   | Option Codes |
|----------------|--------------|
| SZFT-FG-CN2442 | - G - L - X  |

**PRODUCT PRICE**

| Base Price          | Option Prices     |
|---------------------|-------------------|
| \$498               | + \$32 + \$58 + 0 |
| <b>Total Price:</b> |                   |
| \$588               |                   |

**WORKSHEET**

**MODEL NUMBER**

| Model Number | Option Codes         |
|--------------|----------------------|
| _____        | - ____ - ____ - ____ |

**PRODUCT PRICE**







| Base Price          | Option Prices        |
|---------------------|----------------------|
| \$ _____            | + ____ + ____ + ____ |
| <b>Total Price:</b> |                      |
| \$ _____            |                      |

Please contact your ShuttleSystem dealer to obtain discounted project pricing.

## MODULAR ROUNDED SHAPES

### ① CHOOSE SHAPE & SIZE

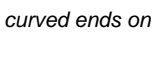
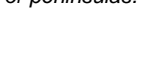
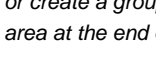
### ② SELECT LEG STYLE for base model number and base price

|  |                             | Fixed Arc Leg  |                | Adjustable Arc Leg |
|--|-----------------------------|----------------|----------------|--------------------|
|  |                             | 29"            |                | 22"-31"            |
|  |                             | Glides         | Casters        | Glides             |
|    | <b>Conference End Left</b>  |                |                |                    |
|  | Size                        |                |                |                    |
|  | 20" D                       | SZFT-FG-CL2054 | SZFT-FC-CL2054 | SZFT-AG-CL2054     |
|  | 54" W                       | <b>\$445</b>   | <b>\$520</b>   | <b>\$497</b>       |
|    | <b>Conference End Right</b> |                |                |                    |
|  | Size                        |                |                |                    |
|  | 24" D                       | SZFT-FG-CL2460 | SZFT-FC-CL2460 | SZFT-AG-CL2460     |
|  | 60" W                       | <b>\$519</b>   | <b>\$592</b>   | <b>\$567</b>       |
|    | <b>Half Round</b>           |                |                |                    |
|  | Size                        |                |                |                    |
|  | 24" D                       | SZFT-FG-CL3060 | SZFT-FC-CL3060 | SZFT-AG-CL3060     |
|  | 60" W                       | <b>\$525</b>   | <b>\$598</b>   | <b>\$576</b>       |
|  | <b>Conference Pod</b>       |                |                |                    |
|  | Size                        |                |                |                    |
|  | 20" D                       | SZFT-FG-CR2054 | SZFT-FC-CR2054 | SZFT-AG-CR2054     |
|  | 54" W                       | <b>\$445</b>   | <b>\$520</b>   | <b>\$497</b>       |
|  | <b>Conference End Left</b>  |                |                |                    |
|  | Size                        |                |                |                    |
|  | 24" D                       | SZFT-FG-CR2460 | SZFT-FC-CR2460 | SZFT-AG-CR2460     |
|  | 60" W                       | <b>\$519</b>   | <b>\$592</b>   | <b>\$567</b>       |
|  | <b>Conference End Right</b> |                |                |                    |
|  | Size                        |                |                |                    |
|  | 30" D                       | SZFT-FG-CR3060 | SZFT-FC-CR3060 | SZFT-AG-CR3060     |
|  | 60" W                       | <b>\$525</b>   | <b>\$598</b>   | <b>\$576</b>       |
|  | <b>Half Round</b>           |                |                |                    |
|  | Size                        |                |                |                    |
|  | 24" D                       | SZFT-FG-HR2448 | SZFT-FC-HR2448 | SZFT-AG-HR2448     |
|  | 48" W                       | <b>\$459</b>   | <b>\$529</b>   | <b>\$505</b>       |
|  | <b>Conference Pod</b>       |                |                |                    |
|  | Size                        |                |                |                    |
|  | 27" D                       | SZFT-FG-HR2754 | SZFT-FC-HR2754 | SZFT-AG-HR2754     |
|  | 54" W                       | <b>\$488</b>   | <b>\$559</b>   | <b>\$539</b>       |
|  | <b>Conference Pod</b>       |                |                |                    |
|  | Size                        |                |                |                    |
|  | 30" D                       | SZFT-FG-HR3060 | SZFT-FC-HR3060 | SZFT-AG-HR3060     |
|  | 60" W                       | <b>\$501</b>   | <b>\$575</b>   | <b>\$551</b>       |
|  | <b>Conference Pod</b>       |                |                |                    |
|  | Size                        |                |                |                    |
|  | 30" D                       | SZFT-FG-CP3048 | SZFT-FC-CP3048 | SZFT-AG-CP3048     |
|  | 48" W                       | <b>\$564</b>   | <b>\$636</b>   | <b>\$614</b>       |

### USING MODULAR ROUNDED SHAPES

#### Conference End Groupings

Combine with other modular shapes to make ovals, peninsulas outside corners or to create curved ends on straight rows.



#### Half Round Groupings

Combine with other modular shapes to make circles, ovals or peninsulas.

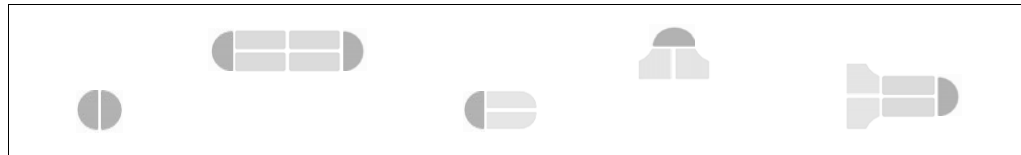

#### Conference Pod Groupings

Expand a desk or workspace with a small conference area or create a group gathering area at the end of a row.

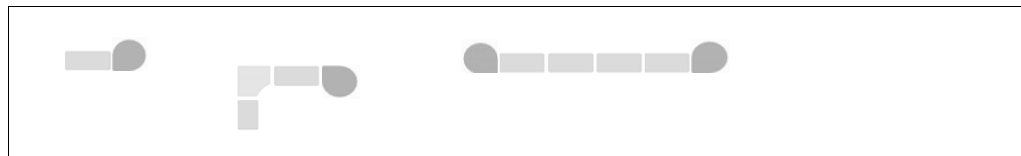



**③ ADD OPTION CODES and PRICES**

Add an Option Code for each category to base Model Number.  
Add the price for each selected Option to base price.

| Top Cutout   |
|--|
| <p><b>-X</b><br/>No cutout<br/>N/C</p>                   |
| <p><b>-G</b><br/>One 3" Grommet<br/><br/><b>\$32</b></p> |
| <p><b>-2</b><br/>Two Grommets<br/><br/><b>\$64</b></p>   |
| <p><b>-E</b><br/>MiniPort<br/><br/><b>\$294</b></p>      |

| ShuttleLatch   |
|--|
| <p><b>-X</b><br/>No Latch<br/>N/C</p>                  |
| <p><b>-L</b><br/>Shuttlelatch<br/><br/><b>\$58</b></p> |

| Wire Tray  |
|--|
| <p><b>-X</b><br/>No Modesty Tray<br/>N/C</p>                                   |
| <p><b>-M</b><br/>12" Modesty Height<br/>Wire Manager<br/><br/><b>\$186</b></p> |

*\*Modesty Panel Option  
not available on  
Conference Pod*

**EXAMPLE**

- ① 24 x 60 Conference End Left ShuttleZone Table
- ② on Fixed Arc Legs with Glides and...
- ③ one grommet, ShuttleLatch, no wire tray

**MODEL NUMBER**

| Model Number   | Option Codes |
|----------------|--------------|
| SZFT-FG-CL2460 | - G - L - X  |

**PRODUCT PRICE**

| Base Price          | Option Prices     |
|---------------------|-------------------|
| \$519               | + \$32 + \$58 + 0 |
| <b>Total Price:</b> |                   |
| <b>\$609</b>        |                   |

**WORKSHEET**

**MODEL NUMBER**

| Model Number | Option Codes |
|--------------|--------------|
| _____        | - - - -      |

**PRODUCT PRICE**

| Base Price          | Option Prices           |
|---------------------|-------------------------|
| \$ _____            | + _____ + _____ + _____ |
| <b>Total Price:</b> |                         |
| \$ _____            |                         |



*Please contact your ShuttleSystem dealer  
to obtain discounted project pricing.*

## SPECIALTY SHAPES



### ① CHOOSE SHAPE & SIZE

### ② SELECT LEG STYLE for base model number and base price

|  |       | Fixed Arc Leg                  |                                | Adjustable Arc Leg             |
|--|-------|--------------------------------|--------------------------------|--------------------------------|
|  |       | 29"                            |                                | 22"-31'                        |
| Width  | Size  | Glides                         | Casters                        | Glides                         |
| <b>Round</b><br>     | 36"   | SZFT-FG-RD3636<br><b>\$529</b> | SZFT-FC-RD3636<br><b>\$603</b> | SZFT-AG-RD3636<br><b>\$580</b> |
|  | 42"   | SZFT-FG-RD4242<br><b>\$539</b> | SZFT-FC-RD4242<br><b>\$612</b> | SZFT-AG-RD4242<br><b>\$588</b> |
|  | 48"   | SZFT-FG-RD4848<br><b>\$576</b> | SZFT-FC-RD4848<br><b>\$650</b> | SZFT-AG-RD4848<br><b>\$625</b> |
|  | 54"   | SZFT-FG-RD5454<br><b>\$702</b> | SZFT-FC-RD5454<br><b>\$775</b> | SZFT-AG-RD5454<br><b>\$751</b> |
|  | 60"   | SZFT-FG-RD6060<br><b>\$727</b> | SZFT-FC-RD6060<br><b>\$798</b> | SZFT-AG-RD6060<br><b>\$775</b> |
| <b>Trapezoid</b><br> | 24" D | SZFT-FG-TR2448<br><b>\$457</b> | SZFT-FC-TR2448<br><b>\$529</b> | SZFT-AG-TR2448<br><b>\$505</b> |
|  | 48" W |                                |                                |                                |
|  | 27" D | SZFT-FG-TR2754<br><b>\$488</b> | SZFT-FC-TR2754<br><b>\$561</b> | SZFT-AG-TR2754<br><b>\$539</b> |
|  | 54" W |                                |                                |                                |
| <b>Kidney</b><br>  | 30" D | SZFT-FG-TR3060<br><b>\$501</b> | SZFT-FC-TR3060<br><b>\$576</b> | SZFT-AG-TR3060<br><b>\$551</b> |
|  | 60" W |                                |                                |                                |
|  | 48" D | SZFT-FG-KD4872<br><b>\$895</b> | SZFT-FC-KD4872<br><b>\$968</b> | SZFT-AG-KD4872<br><b>\$945</b> |
|  | 72" W |                                |                                |                                |

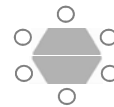

Trapezoids can be used in pairs to create six-person groupings.



Kidneys are typically used in primary grades to center students around instructor.



## ACCESSORIES

### Mobile Storage Pedestals

Mobile

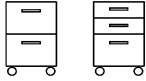

2-Drawer (12"/12")

2PED-18-M-12/12-L  
**\$891**

3-Drawer (6"/6"/12")

3PED-18-M-6/6/12-L  
**\$940**

- > Sized to roll beneath 29" high tables
- > Dimensions 15" W x 19" D x 27" H
- > Locking Drawers

### Pencil Drawers

Basic Pencil Drawer

Basic  
ACC-PD-B  
**\$128**

Professional Pencil Drawer

ACC-PD-P  
**\$410**

### Book Boxes

Wire Book Box

Basic  
ACC-WB  
**\$50**

Molded Book Box

ACC-MB  
**\$50**

Metal Book Box

Acc-MTL-Bookbox  
**\$0**

### Technology Accessories

Basic CPU Holder  
(for Pedestal Leg tables only)

ACC-CPUH-B  
**\$223**

Deluxe CPU Holder - Fixed

ACC-CPUH-DF  
**\$310**

Deluxe CPU Holder  
Slide-out / Swivel

ACC-CPUH-DS  
**\$431**

Keyboard Tray

ACC-K24  
**\$243**

MiniPort

ACC-MINIPOINT  
**\$294**

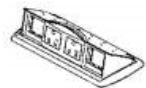

### Storage Totes

3" Tote

ACC-T3  
**\$31**

6" Tote

ACC-T6  
**\$44**

# ShuttleZone

## Instructor & Administrative Desks



Open Space Desks



Latchable Desks



Pedestal Desks





Techera  
Workstations

Wonderfully flexible and technology-savvy, our Mobile ShuttleZone Workspaces are perfect for the leaders and teachers of today's schools.

Choose from dozens of high-performance formats to suit your needs and budget.

# ShuttleZone Instructor Desks & Administrative Desks

## INDEX

| CATEGORY                               |   | PAGE                                  |         |
|--|---|---------------------------------------|---------|
| Instructor Desks & Administrator Desks |    | Open Space Desks                      | 16 - 17 |
|  |   | Open Space Mobile Workspace / Storage | 18 - 19 |
|  |    | Latchable Desks                       | 20 - 21 |
|  |   | Latchable Mobile Workspace / Storage  | 22 - 23 |
|  |    | Single-Pedestal Desks                 | 24 - 27 |
|  |   | Double-Pedestal Desks                 | 28 - 29 |
|  |  | Techera Workstations                  | 30 - 31 |
| ShuttleZone Accessories                |   | Mobile Pedestals                      | 32      |
|  |   | Storage Totes                         | 32      |
|  |   | Book Boxes & Center Drawers           | 32      |
|  |   | Technology Accessories                | 32      |





### Shipping of ShuttleZone Instructor Desks & Administrative Desks

- > All orders of 10 stations and over will be bulk packed on pallets.
- > Orders under 10 stations may be individually cartoned (large components may also be palletized).
- > Freight classification is 70 for non-pedestal desks.
- > Freight classification is 125 for pedestal desks and Techeras.



## ◁ OPEN SPACE DESKS

### ① CHOOSE SHAPE & SIZE

|  | Size           |
|--|----------------|
| <br><b>Flux Desk</b>               | 30" D<br>54" W |
|  | 30" D<br>60" W |
|  | 30" D<br>72" W |
|  | 30" D<br>72" W |
| <br><b>Straight Desk</b>           | 30" D<br>54" W |
|  | 30" D<br>60" W |
|  | 30" D<br>72" W |
|  | 30" D<br>72" W |
| <br><b>Conference Desk Left</b>   | 30" D<br>54" W |
|  | 30" D<br>60" W |
|  | 30" D<br>72" W |
|  | 30" D<br>72" W |
| <br><b>Conference Desk Right</b> | 30" D<br>54" W |
|  | 30" D<br>60" W |
|  | 30" D<br>72" W |
|  | 30" D<br>72" W |

### ② SELECT LEG STYLE for base model number and base price

| Fixed S Leg    |                | Adjustable Arc Leg |         | Fixed Arc Leg  |                |
|----------------|----------------|--------------------|---------|----------------|----------------|
| 29"            |                | 22"-31'            |         | 29"            |                |
| Glides         | Casters        | Glides             | Casters | Glides         | Casters        |
| SZFT-SG-FX3054 | SZFT-SC-FX3054 | SZFT-AG-FX3054     |         | SZFT-FG-FX3054 | SZFT-FC-FX3054 |
| <b>\$488</b>   | <b>\$559</b>   | <b>\$539</b>       |         | <b>\$488</b>   | <b>\$559</b>   |
| SZFT-SG-FX3060 | SZFT-SC-FX3060 | SZFT-AG-FX3060     |         | SZFT-FG-FX3060 | SZFT-FC-FX3060 |
| <b>\$525</b>   | <b>\$598</b>   | <b>\$576</b>       |         | <b>\$525</b>   | <b>\$598</b>   |
| SZFT-SG-FX3072 | SZFT-SC-FX3072 | SZFT-AG-FX3072     |         | SZFT-FG-FX3072 | SZFT-FC-FX3072 |
| <b>\$609</b>   | <b>\$680</b>   | <b>\$657</b>       |         | <b>\$609</b>   | <b>\$680</b>   |
| SZFT-SG-ST3054 | SZFT-SC-ST3054 | SZFT-AG-ST3054     |         | SZFT-FG-ST3054 | SZFT-FC-ST3054 |
| <b>\$488</b>   | <b>\$559</b>   | <b>\$539</b>       |         | <b>\$488</b>   | <b>\$559</b>   |
| SZFT-SG-ST3060 | SZFT-SC-ST3060 | SZFT-AG-ST3060     |         | SZFT-FG-ST3060 | SZFT-FC-ST3060 |
| <b>\$525</b>   | <b>\$598</b>   | <b>\$576</b>       |         | <b>\$525</b>   | <b>\$598</b>   |
| SZFT-SG-ST3072 | SZFT-SC-ST3072 | SZFT-AG-ST3072     |         | SZFT-FG-ST3072 | SZFT-FC-ST3072 |
| <b>\$609</b>   | <b>\$680</b>   | <b>\$657</b>       |         | <b>\$609</b>   | <b>\$680</b>   |
| SZFT-SG-BL3054 | SZFT-SC-BL3054 | SZFT-AG-BL3054     |         | SZFT-FG-BL3054 | SZFT-FC-BL3054 |
| <b>\$488</b>   | <b>\$559</b>   | <b>\$539</b>       |         | <b>\$488</b>   | <b>\$559</b>   |
| SZFT-SG-BL3060 | SZFT-SC-BL3060 | SZFT-AG-BL3060     |         | SZFT-FG-BL3060 | SZFT-FC-BL3060 |
| <b>\$525</b>   | <b>\$598</b>   | <b>\$576</b>       |         | <b>\$525</b>   | <b>\$598</b>   |
| SZFT-SG-BL3072 | SZFT-SC-BL3072 | SZFT-AG-BL3072     |         | SZFT-FG-BL3072 | SZFT-FC-BL3072 |
| <b>\$609</b>   | <b>\$680</b>   | <b>\$657</b>       |         | <b>\$609</b>   | <b>\$680</b>   |
| SZFT-SG-BR3054 | SZFT-SC-BR3054 | SZFT-AG-BR3054     |         | SZFT-FG-BR3054 | SZFT-FC-BR3054 |
| <b>\$488</b>   | <b>\$559</b>   | <b>\$539</b>       |         | <b>\$488</b>   | <b>\$559</b>   |
| SZFT-SG-BR3060 | SZFT-SC-BR3060 | SZFT-AG-BR3060     |         | SZFT-FG-BR3060 | SZFT-FC-BR3060 |
| <b>\$525</b>   | <b>\$598</b>   | <b>\$576</b>       |         | <b>\$525</b>   | <b>\$598</b>   |
| SZFT-SG-BR3072 | SZFT-SC-BR3072 | SZFT-AG-BR3072     |         | SZFT-FG-BR3072 | SZFT-FC-BR3072 |
| <b>\$609</b>   | <b>\$680</b>   | <b>\$657</b>       |         | <b>\$609</b>   | <b>\$680</b>   |

### WORKS WELL WITH OTHERS:

Customize and expand your Open Space Desk with these matching storage and workspace units

#### Satellite Support Module

An Open Space favorite: available in two sizes and various storage formats.

See page 18

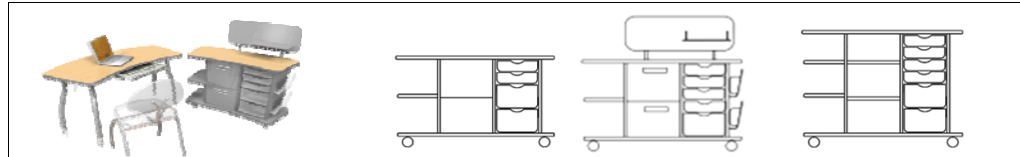

#### Complementary Shapes

Expand your workspace instantly with any ShuttleZone MultiPurpose table shape.

See pages 2 - 12



#### Mobile Wardrobes & Cabinets

Equip yourself with flexible storage for supplies, equipment and personal belongings.

See pages 34 - 44

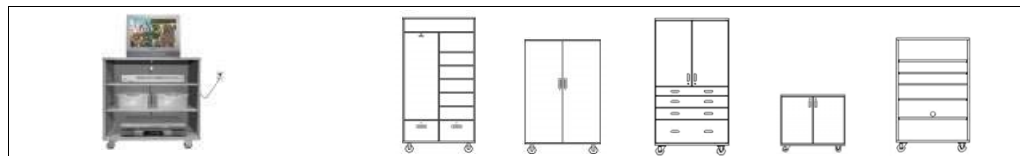

**Adjustable Pedestal Leg**



| Glides                         | Casters                        |
|--------------------------------|--------------------------------|
| SZFT-HG-FX3054<br><b>\$681</b> | SZFT-HC-FX3054<br><b>\$774</b> |
| SZFT-HG-FX3060<br><b>\$700</b> | SZFT-HC-FX3060<br><b>\$792</b> |
| SZFT-HG-FX3072<br><b>\$788</b> | SZFT-HC-FX3072<br><b>\$876</b> |
| SZFT-HG-ST3054<br><b>\$681</b> | SZFT-HC-ST3054<br><b>\$774</b> |
| SZFT-HG-ST3060<br><b>\$700</b> | SZFT-HC-ST3060<br><b>\$792</b> |
| SZFT-HG-ST3072<br><b>\$788</b> | SZFT-HC-ST3072<br><b>\$876</b> |
| SZFT-HG-BL3054<br><b>\$681</b> | SZFT-HC-BL3054<br><b>\$774</b> |
| SZFT-HG-BL3060<br><b>\$700</b> | SZFT-HC-BL3060<br><b>\$792</b> |
| SZFT-HG-BL3072<br><b>\$788</b> | SZFT-HC-BL3072<br><b>\$876</b> |
| SZFT-HG-BR3054<br><b>\$681</b> | SZFT-HC-BR3054<br><b>\$774</b> |
| SZFT-HG-BR3060<br><b>\$700</b> | SZFT-HC-BR3060<br><b>\$792</b> |
| SZFT-HG-BR3072<br><b>\$788</b> | SZFT-HC-BR3072<br><b>\$876</b> |

**③ ADD OPTION CODES and PRICES**

Add Option Codes to base Model Number.  
Add each selected Option price to base price.

**Top Cutout**

**-X**  
No cutout  
**N/C**

**-G**  
One 3" Grommet  
**\$32**

**-E**  
MiniPort  
**\$294**

**Wire Tray**

**-X**  
No Modesty Tray  
**N/C**

**-M**  
12" Modesty Height  
Wire Manager  
**\$186**

**EXAMPLE**

- ① 30 x 60 Flux Desk
- ② on Fixed S-Legs with glides and...
- ③ no Top Cutout and Modesty Height Wire Tray

**MODEL NUMBER**

| Model Number   | Option Codes                                       |
|----------------|--|
| SZFT-SG-FX3060 | - X - X - M<br><small>no latch Δ available</small> |

**PRODUCT PRICE**

| Base Price          | Option Prices  |
|---------------------|--|
| \$525               | + 0 + 0 + \$186<br><small>no latch Δ available</small> |
| <b>Total Price:</b> |  |
| \$711               |  |

**WORKSHEET**

**MODEL NUMBER**

| Model Number | Option Codes                                   |
|--------------|--|
|              | - - X -<br><small>no latch Δ available</small> |

**PRODUCT PRICE**

| Base Price          | Option Prices                                  |
|---------------------|--|
| \$                  | + + 0 +<br><small>no latch Δ available</small> |
| <b>Total Price:</b> |  |
| \$                  |  |

| Available Accessories: | see page |
|------------------------|----------|
| Power / Data MiniPort  | 32       |
| Keyboard Tray          | 32       |
| CPU Holders            | 32       |
| Center Drawer          | 32       |
| Mobile Pedestal        | 32       |

Please contact your ShuttleSystem dealer to obtain discounted project pricing.

# ShuttleZone Mobile Workspace / Storage



## ◁ OPEN SPACE MOBILE WORKSPACE / STORAGE

### Satellite Support Modules

**LOW - 29" (48" W x 24" D)**

**STANDARD CONFIGURATION**

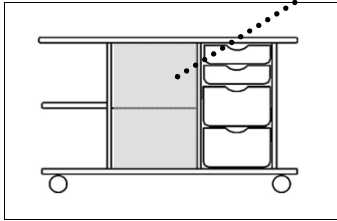

All Shelves in Shelf Bay  
4 Totes in Tote Bay

**SHELF BAY FORMATS**

| Standard       | 1 Drawer             | 2 Drawers                  | 3 Drawers                             |
|----------------|----------------------|----------------------------|---------------------------------------|
|                |                      |                            |                                       |
| Shelf<br>Shelf | Shelf<br>File Drawer | File Drawer<br>File Drawer | 6" Drawer<br>6" Drawer<br>File Drawer |

Add for Shelf Bay selection:

| Standard | 1 Drawer | 2 Drawers | 3 Drawers |
|----------|----------|-----------|-----------|
| -XX22    | -X122    | -X222     | -2122     |
| \$0      | \$222    | \$441     | \$528     |

**STORAGE ACCESSORIES**

Paper Trays

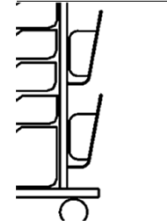

Two trays,  
vertical

Add for Storage Accessories:

|      |
|------|
| - 2  |
| \$95 |

**TALL - 42" (48" W x 24" D)**

**STANDARD CONFIGURATION**

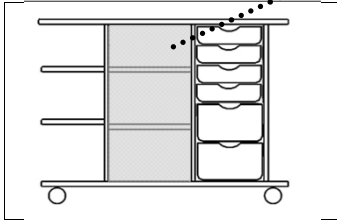

All Shelves in Shelf Bay  
6 Totes in Totes Bay

**SHELF BAY FORMATS**

| Standard                | 1 Drawer                      | 2 Drawers                           | 3 Drawers   | 4 Drawers  |
|-------------------------|-------------------------------|-------------------------------------|---|--|
|                         |                               |                                     |   |  |
| Shelf<br>Shelf<br>Shelf | Shelf<br>Shelf<br>File Drawer | Shelf<br>File Drawer<br>File Drawer | 6" Drawer<br>Half Shelf<br>File Drawer<br>File Drawer | 6" Drawer<br>6" Drawer<br>File Drawer<br>File Drawer |

Add for Shelf Bay selection:

| Standard | 1 Drawer | 2 Drawers | 3 Drawers | 4 Drawers |
|----------|----------|-----------|-----------|-----------|
| -XX42    | -X142    | -X242     | -1242     | -2242     |
| \$0      | \$222    | \$441     | \$594     | \$746     |

**STORAGE ACCESSORIES**

Paper Trays

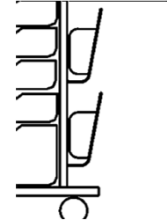

Three trays,  
vertical

Add for Storage Accessories:

|       |
|-------|
| - 3   |
| \$140 |

## Mobile Storage Pedestals

> Sized to roll beneath  
29" high ShuttleZone Desks

> Dimensions:  
15" W x 19" D x 27" H

> Locking Drawers

Two Drawers

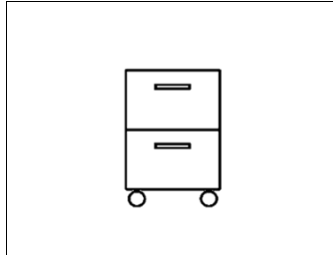

12" File  
12" File

2PED-18-M-12/12-L

**\$891**

Three Drawers



6" Drawer  
6" Drawer  
12" File

3PED-18-M-6/6/12-L

**\$940**



## ◁ LATCHABLE DESKS

### ① CHOOSE SHAPE & SIZE

|                              | Size           |
|------------------------------|----------------|
| <b>Straight Desk</b>         | 30" D<br>54" W |
|                              | 30" D<br>60" W |
|                              | 30" D<br>72" W |
|                              | 30" D<br>72" W |
| <b>Conference Desk Left</b>  | 30" D<br>54" W |
|                              | 30" D<br>60" W |
|                              | 30" D<br>72" W |
|                              | 30" D<br>72" W |
| <b>Conference Desk Right</b> | 30" D<br>54" W |
|                              | 30" D<br>60" W |
|                              | 30" D<br>72" W |
|                              | 30" D<br>72" W |

### ② SELECT LEG STYLE for base model number and base price

| Fixed S Leg    |                | Adjustable Arc Leg |         | Fixed Arc Leg  |                |
|----------------|----------------|--------------------|---------|----------------|----------------|
| 29"            |                | 22"-31'            |         | 29"            |                |
| Glides         | Casters        | Glides             | Casters | Glides         | Casters        |
| SZFT-SG-ST3054 | SZFT-SC-ST3054 | SZFT-AG-ST3054     |         | SZFT-FG-ST3054 | SZFT-FC-ST3054 |
| <b>\$488</b>   | <b>\$559</b>   | <b>\$539</b>       |         | <b>\$488</b>   | <b>\$559</b>   |
| SZFT-SG-ST3060 | SZFT-SC-ST3060 | SZFT-AG-ST3060     |         | SZFT-FG-ST3060 | SZFT-FC-ST3060 |
| <b>\$525</b>   | <b>\$598</b>   | <b>\$576</b>       |         | <b>\$525</b>   | <b>\$598</b>   |
| SZFT-SG-ST3072 | SZFT-SC-ST3072 | SZFT-AG-ST3072     |         | SZFT-FG-ST3072 | SZFT-FC-ST3072 |
| <b>\$609</b>   | <b>\$680</b>   | <b>\$657</b>       |         | <b>\$609</b>   | <b>\$680</b>   |
| SZFT-SG-BL3054 | SZFT-SC-BL3054 | SZFT-AG-BL3054     |         | SZFT-FG-BL3054 | SZFT-FC-BL3054 |
| <b>\$488</b>   | <b>\$559</b>   | <b>\$539</b>       |         | <b>\$488</b>   | <b>\$559</b>   |
| SZFT-SG-BL3060 | SZFT-SC-BL3060 | SZFT-AG-BL3060     |         | SZFT-FG-BL3060 | SZFT-FC-BL3060 |
| <b>\$525</b>   | <b>\$598</b>   | <b>\$576</b>       |         | <b>\$525</b>   | <b>\$598</b>   |
| SZFT-SG-BL3072 | SZFT-SC-BL3072 | SZFT-AG-BL3072     |         | SZFT-FG-BL3072 | SZFT-FC-BL3072 |
| <b>\$609</b>   | <b>\$680</b>   | <b>\$657</b>       |         | <b>\$609</b>   | <b>\$680</b>   |
| SZFT-SG-BR3054 | SZFT-SC-BR3054 | SZFT-AG-BR3054     |         | SZFT-FG-BR3054 | SZFT-FC-BR3054 |
| <b>\$488</b>   | <b>\$559</b>   | <b>\$539</b>       |         | <b>\$488</b>   | <b>\$559</b>   |
| SZFT-SG-BR3060 | SZFT-SC-BR3060 | SZFT-AG-BR3060     |         | SZFT-FG-BR3060 | SZFT-FC-BR3060 |
| <b>\$525</b>   | <b>\$598</b>   | <b>\$576</b>       |         | <b>\$525</b>   | <b>\$598</b>   |
| SZFT-SG-BR3072 | SZFT-SC-BR3072 | SZFT-AG-BR3072     |         | SZFT-FG-BR3072 | SZFT-FC-BR3072 |
| <b>\$609</b>   | <b>\$680</b>   | <b>\$657</b>       |         | <b>\$609</b>   | <b>\$680</b>   |

### WORKS WELL WITH OTHERS:

Customize and expand your Latchable Desk with these matching storage and workspace units.

#### Latchable Storage Return

A mobile and comprehensive storage system that latches to your desk. In two sizes.

See page 22

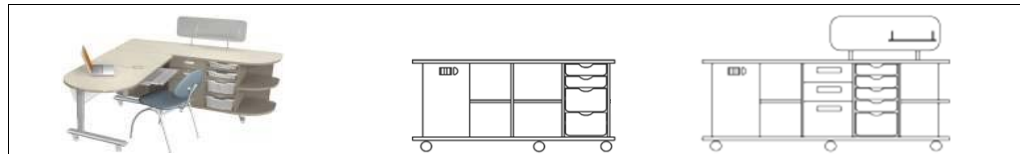

#### Complementary Shapes

Add ShuttleZone shapes to expand your desk or create L-shaped workspaces.

See pages 2 - 12

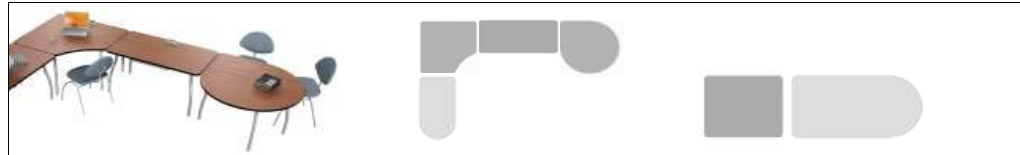

#### Mobile Pedestals

Tuck a Mobile Pedestal beneath any desk or a complimentary shape.

See page 23

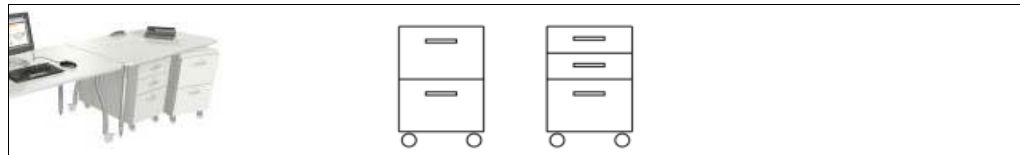

#### Mobile Storage

Equip yourself with flexible storage for supplies, equipment and personal belongings.

See pages 34 - 44

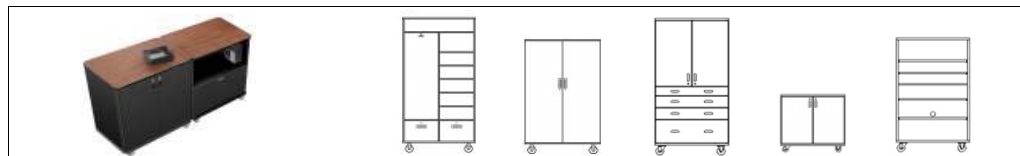



**Adjustable Pedestal Leg**



| Glides                         | Casters                        |
|--------------------------------|--------------------------------|
| SZFT-HG-ST3054<br><b>\$681</b> | SZFT-HC-ST3054<br><b>\$774</b> |
| SZFT-HG-ST3060<br><b>\$700</b> | SZFT-HC-ST3060<br><b>\$792</b> |
| SZFT-HG-ST3072<br><b>\$788</b> | SZFT-HC-ST3072<br><b>\$876</b> |
| SZFT-HG-BL3054<br><b>\$681</b> | SZFT-HC-BL3054<br><b>\$774</b> |
| SZFT-HG-BL3060<br><b>\$700</b> | SZFT-HC-BL3060<br><b>\$792</b> |
| SZFT-HG-BL3072<br><b>\$788</b> | SZFT-HC-BL3072<br><b>\$876</b> |
| SZFT-HG-BR3054<br><b>\$681</b> | SZFT-HC-BR3054<br><b>\$774</b> |
| SZFT-HG-BR3060<br><b>\$700</b> | SZFT-HC-BR3060<br><b>\$792</b> |
| SZFT-HG-BR3072<br><b>\$788</b> | SZFT-HC-BR3072<br><b>\$876</b> |



**PLEASE NOTE:**

The Latchable Return works best with desks on Pedestal style legs.

**③ ADD OPTION CODES and PRICES**

Add Option Codes to base Model Number.  
Add each selected Option price to base price.

**Top Cutout**

**-X**  
No cutout  
**N/C**

**-G**  
One 3" Grommet  
**\$32**

**-E**  
MiniPort  
**\$294**

**Wire Tray**

**-X**  
No Modesty Tray  
**N/C**

**-M**  
12" Modesty Height  
Wire Manager  
**\$186**

**ShuttleLatch**

**-X**  
No Latch  
**N/C**

**-L**  
ShuttleLatch  
**\$58**

**EXAMPLE**

Assumes ShuttleLatch on all desks

- ① 30 x 60 Conference Desk Left ShuttleZone Tal
- ② on Fixed Arc Legs with Glides and...
- ③ one grommet, ShuttleLatch, no wire tray

**MODEL NUMBER**

| Model Number   | Option Codes |
|----------------|--------------|
| SZFT-FG-ST3060 | - G - L - X  |

ShuttleLatch Code

| Base Price         | Option Prices     |
|--------------------|-------------------|
| \$525              | + \$32 + \$58 + 0 |
| ShuttleLatch Price |                   |
| <b>\$615</b>       |                   |

**WORKSHEET**

**MODEL NUMBER**

| Model Number | Option Codes |
|--------------|--------------|
| -            | - - -        |

ShuttleLatch Code

**PRODUCT PRICE**

| Base Price          | Option Prices |
|---------------------|---------------|
| \$                  | + + +         |
| ShuttleLatch Price  |               |
| <b>Total Price:</b> |               |
| \$                  |               |

Please contact your ShuttleSystem dealer to obtain discounted project pricing.

| Available Accessories: | see page |
|------------------------|----------|
| Power / Data MiniPort  | 32       |
| Keyboard Tray          | 32       |
| CPU Holders            | 32       |
| Center Drawer          | 32       |
| Mobile Pedestal        | 32       |

# ShuttleZone Mobile Workspace / Storage



## ◁ LATCHABLE MOBILE WORKSPACE / STORAGE

### Latchable Returns

#### EXTENDED - 72" Long (29" H x 24" D)

##### STANDARD CONFIGURATION

Choose Left or Right (shown below) orientation

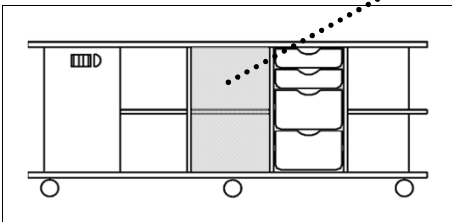

> All Shelves in Shelf E > No Auxiliary Doors  
> 4 Totes in Tote Bay > No Organizer Panel

| Left           | Right          |
|----------------|----------------|
| SZLR-L72       | SZLR-R72       |
| <b>\$2,122</b> | <b>\$2,122</b> |

##### SHELF BAY FORMATS

Standard 1 Drawer 2 Drawers 3 Drawers

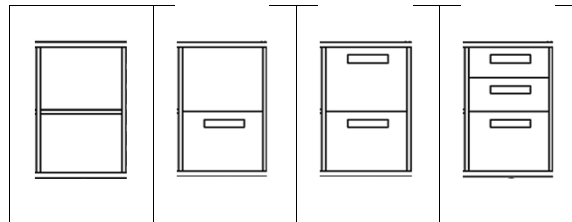

Shelf Shelf File Drawer 6" Drawer  
Shelf File Drawer File Drawer 6" Drawer  
File Drawer

| Add for Shelf Bay selection: |              |              |              |
|------------------------------|--------------|--------------|--------------|
| -XX22                        | -X122        | -X222        | -2122        |
| <b>\$0</b>                   | <b>\$222</b> | <b>\$441</b> | <b>\$528</b> |

##### STORAGE ACCESSORIES

Auxiliary Bay Doors

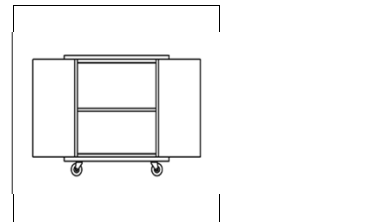

Locking doors on front end storage provide security

| Add for Storage Accessories: |
|------------------------------|
| - D                          |
| <b>\$166</b>                 |

#### COMPACT - 61" Long (29" H x 24" D)

##### STANDARD CONFIGURATION

Choose Left or Right (shown below) orientation

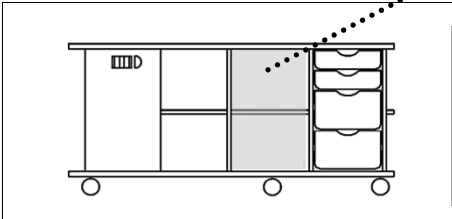

> All Shelves in Shelf E > No Auxiliary Doors  
> 4 Totes in Tote Bay > No Organizer Panel

| Left           | Right          |
|----------------|----------------|
| SZLR-L60       | SZLR-R60       |
| <b>\$2,016</b> | <b>\$2,016</b> |

##### SHELF BAY FORMATS

Standard 1 Drawer 2 Drawers 3 Drawers

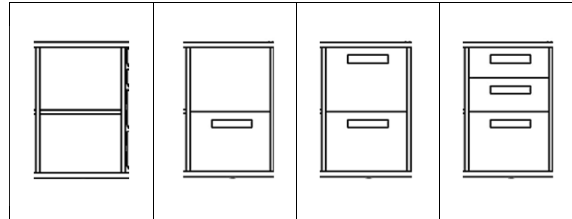

Shelf Shelf File Drawer 6" Drawer  
Shelf File Drawer File Drawer 6" Drawer  
File Drawer

| Add for Shelf Bay selection: |              |              |              |
|------------------------------|--------------|--------------|--------------|
| -XX22                        | -X122        | -X222        | -2122        |
| <b>\$0</b>                   | <b>\$222</b> | <b>\$441</b> | <b>\$528</b> |

##### STORAGE ACCESSORIES

Auxiliary Bay Doors

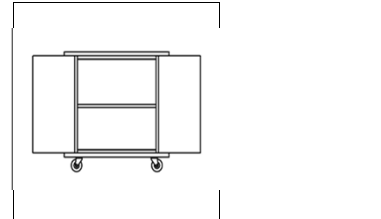

Locking doors on front end storage provide security

| Add for Storage Accessories: |
|------------------------------|
| - D                          |
| <b>\$166</b>                 |

The Latchable Return works best with desks that have the ShuttleLatch option and Pedestal style legs.

## Mobile Storage Pedestals

- > Sized to roll beneath  
29" high ShuttleZone Desks
- > Dimensions:  
15" W x 19" D x 27" H
- > Locking Drawers

Two Drawers



12" File  
12" File

2PED-18-M-12/12-L

**\$891**

Three Drawers



6" Drawer  
6" Drawer  
12" File

3PED-18-M-6/6/12-L

**\$940**



## ◀ Single Pedestal Desks - Left Hand Pedestal

① CHOOSE SIZE for base model number & price

② CHOOSE LEFT PESESTAL

③ CHOOSE RIGHT SUPPORT

Add Codes for left and right supports to base Model Number  
and add accompanying prices to the base price.

|  | Size  |                |
|--|-------|----------------|
|  | 30" D | SZPD54         |
|  | 54" W | <b>\$1,253</b> |
|  | 30" D | SZPD60         |
|  | 60" W | <b>\$1,291</b> |
|  | 30" D | SZPD72         |
|  | 72" W | <b>\$1,372</b> |

| Glides  |  | Casters   |  | Glides                             |  | Casters                                    |  |
|---|--|---|--|------------------------------------|--|--|--|
| <b>-GO</b><br>Open Shelves<br>N/C               |  | <b>-CO</b><br>Open Shelves<br>N/C               |  | <b>-GS</b><br>Fixed S Leg<br>N/C   |  | <b>-CS</b><br>Fixed S Leg<br><b>\$38</b>   |  |
| <b>-GD</b><br>Shelves with Door<br><b>\$153</b> |  | <b>-CD</b><br>Shelves with Door<br><b>\$153</b> |  | <b>-GA</b><br>Fixed Arc Leg<br>N/C |  | <b>-CA</b><br>Fixed Arc Leg<br><b>\$38</b> |  |
| <b>-G1</b><br>One Drawer<br><b>\$224</b>        |  | <b>-C1</b><br>One Drawer<br><b>\$224</b>        |  |                                    |  |  |  |
| <b>-G2</b><br>Two Drawers<br><b>\$444</b>       |  | <b>-C2</b><br>Two Drawers<br><b>\$444</b>       |  |                                    |  |  |  |
| <b>-G3</b><br>Three Drawers<br><b>\$534</b>     |  | <b>-C3</b><br>Three Drawers<br><b>\$534</b>     |  |                                    |  |  |  |



### Built-in Writing Trays:





All supporting pedestals include space-saving pull-out writing trays

### Locks:

Locks are standard on all drawers and doors.

**④ ADD OPTION CODES and PRICES**

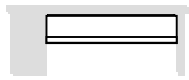
Add Option Codes to base Model Number.  
Add each selected Option price to base price.

| Top Cutout  | Modesty Panel / Wire Tray   |
|---|---|
| <p><b>-X</b><br/>No cutout<br/><b>N/C</b></p>        | <p><b>-X</b><br/>No Modesty Panel<br/><b>N/C</b></p>  |
| <p><b>-G</b><br/>One 3" Grommet<br/><b>\$32</b></p>  | <p><b>-M</b><br/>12" Modesty Height<br/>Wire Manager<br/><b>\$186</b></p>  |
| <p><b>-E</b><br/>MiniPort<br/><b>\$294</b></p>     |   |

| Available Accessories | see page |
|-----------------------|----------|
| Power / Data MiniPort | 32       |
| Keyboard Tray         | 32       |
| Center Drawer         | 32       |

**EXAMPLE**

- ① 30 x 60 Single Pedestal Desk
- ② Three Drawer Glide Pedestal on left,
- ③ glide S-Legs on left and...
- ④ no Top Cutout, no Modesty / Wire Management

**MODEL NUMBER**

| Model Number | Left Ped | Right Leg | Options |
|--------------|----------|-----------|---------|
| SZPD60       | - G3     | - GS      | - X - X |

**PRODUCT PRICE**

| Base Price     | Left Ped | Right Leg | Options |
|----------------|----------|-----------|---------|
| \$1,291        | + \$534  | + 0       | + 0 + 0 |
| <b>\$1,825</b> |          |           |         |

**WORKSHEET**

**MODEL NUMBER**

| Model Number | Left Ped | Right Leg | Options |
|--------------|----------|-----------|---------|
| _____        | - _____  | - _____   | - _____ |

**PRODUCT PRICE**

| Base Price      | Left Ped | Right Leg | Options |
|-----------------|----------|-----------|---------|
| \$ _____        | + _____  | + _____   | + _____ |
| <b>\$ _____</b> |          |           |         |

Please contact your ShuttleSystem dealer to obtain discounted project pricing.



## ◁ Single Pedestal Desks - Right Hand Pedestal





① CHOOSE SIZE for base model number & price







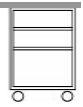

② CHOOSE LEFT SUPPORT

③ CHOOSE RIGHT PEDESTAL

Add Codes for left and right supports to base Model Number  
and add accompanying prices to the base price.

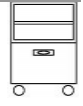
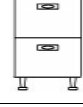
|   | Size  |                |
|---|-------|----------------|
| Straight Desk with<br>Right-Hand Pedestal | 30" D | SZPD54         |
|   | 54" W | <b>\$1,253</b> |
|   | 30" D | SZPD60         |
|   | 60" W | <b>\$1,291</b> |
|   | 30" D | SZPD72         |
|   | 72" W | <b>\$1,372</b> |

| Glides  | Casters   |
|---|---|
| <b>-GS</b><br>Fixed S Leg<br>N/C<br>   | <b>-CS</b><br>Fixed S Leg<br><b>\$38</b><br>   |
| <b>-GA</b><br>Fixed Arc Leg<br>N/C<br> | <b>-CA</b><br>Fixed Arc Leg<br><b>\$38</b><br> |

| Glides   | Casters  |
|--|--|
| <b>-GO</b><br>Open Shelves<br>N/C<br>               | <b>-CO</b><br>Open Shelves<br>N/C<br>               |
| <b>-GD</b><br>Shelves with Door<br><b>\$153</b><br> | <b>-CD</b><br>Shelves with Door<br><b>\$153</b><br> |
| <b>-G1</b><br>One Drawer<br><b>\$224</b><br>      | <b>-C1</b><br>One Drawer<br><b>\$224</b><br>      |
| <b>-G2</b><br>Two Drawers<br><b>\$444</b><br>     | <b>-C2</b><br>Two Drawers<br><b>\$444</b><br>     |
| <b>-G3</b><br>Three Drawers<br><b>\$534</b><br>   | <b>-C3</b><br>Three Drawers<br><b>\$534</b><br>   |



### Built-in Writing Trays:





All supporting pedestals include space-saving pull-out writing trays

### Locks:

Locks are standard on all drawers and doors.

**④ ADD OPTION CODES and PRICES**

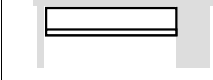
Add Option Codes to base Model Number.  
Add each selected Option price to base price.

| Top Cutout  | Modesty Panel / Wire Tray   |
|---|---|
| <p><b>-X</b><br/>No cutout<br/><b>N/C</b></p>        | <p><b>-X</b><br/>No Modesty Panel<br/><b>N/C</b></p>  |
| <p><b>-G</b><br/>One 3" Grommet<br/><b>\$32</b></p>  | <p><b>-M</b><br/>12" Modesty Height<br/>Wire Manager<br/><b>\$186</b></p>  |
| <p><b>-E</b><br/>MiniPort<br/><b>\$294</b></p>     |   |

| Available Accessories | see page |
|-----------------------|----------|
| Power / Data MiniPort | 32       |
| Keyboard Tray         | 32       |
| Center Drawer         | 32       |

**EXAMPLE**

- ① 30 x 60 Single Pedestal Desk
- ② with glide S-Legs on left,
- ③ Three Drawer Glide Pedestal on right and...
- ④ no Top Cutout, no Modesty / Wire Management

**MODEL NUMBER**

| Model Number | Left Leg | Right Ped | Options |
|--------------|----------|-----------|---------|
| SZPD60       | - GA     | - G3      | - X - X |

**PRODUCT PRICE**

| Base Price     | Left Leg | Right Ped | Options |
|----------------|----------|-----------|---------|
| \$1,291        | + \$0    | + \$534   | + 0 + 0 |
| <b>\$1,825</b> |          |           |         |

**WORKSHEET**

**MODEL NUMBER**

| Model Number | Left Leg | Right Ped | Options |
|--------------|----------|-----------|---------|
| -            | -        | -         | -       |

**PRODUCT PRICE**

| Base Price | Left Leg | Right Ped | Options |
|------------|----------|-----------|---------|
| \$         | +        | +         | + +     |
| <b>\$</b>  |          |           |         |

Please contact your ShuttleSystem dealer to obtain discounted project pricing.



## ◀ Double Pedestal Desks

① CHOOSE SIZE for base model number & price

② CHOOSE LEFT PEDESTAL

③ CHOOSE RIGHT PEDESTAL

Add Pedestal Codes for left and right sides to base Model Number.

Add selected Pedestal prices to the base price.

|   | Size  |                |
|---|-------|----------------|
| Straight Desk with<br>Left & Right Pedestal | 30" D | SZPD54         |
|   | 54" W | <b>\$1,796</b> |
|   | 30" D | SZPD60         |
|   | 60" W | <b>\$1,887</b> |
|   | 30" D | SZPD72         |
|   | 72" W | <b>\$1,968</b> |

|  |   | Glides | Casters |   |  | Glides | Casters |
|--|---|--------|---------|---|--|--------|---------|
|  | <b>-GO</b><br>Open Shelves<br>N/C               |        |         | <b>-CO</b><br>Open Shelves<br>N/C               |  |        |         |
|  | <b>-GD</b><br>Shelves with Door<br><b>\$153</b> |        |         | <b>-CD</b><br>Shelves with Door<br><b>\$153</b> |  |        |         |
|  | <b>-G1</b><br>One Drawer<br><b>\$224</b>        |        |         | <b>-C1</b><br>One Drawer<br><b>\$224</b>        |  |        |         |
|  | <b>-G2</b><br>Two Drawers<br><b>\$444</b>       |        |         | <b>-C2</b><br>Two Drawers<br><b>\$444</b>       |  |        |         |
|  | <b>-G3</b><br>Three Drawers<br><b>\$534</b>     |        |         | <b>-C3</b><br>Three Drawers<br><b>\$534</b>     |  |        |         |







**Built-in Writing Trays:**  
All supporting pedestals include space-saving pull-out writing trays

**Locks:**  
Locks are standard on all drawers and doors.

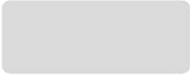

**④ ADD OPTION CODES and PRICES**

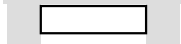
Add Option Codes to base Model Number.  
Add each selected Option price to base price.

| Top Cutout  | Modesty Panel / Wire Tray   |
|---|---|
| <p><b>-X</b><br/>No cutout<br/><b>N/C</b></p>        | <p><b>-X</b><br/>No Modesty Panel<br/><b>N/C</b></p>  |
| <p><b>-G</b><br/>One 3" Grommet<br/><b>\$32</b></p>  | <p><b>-HM</b><br/>Plain Modesty Panel<br/><b>\$94</b></p>  |
| <p><b>-E</b><br/>MiniPort<br/><b>\$294</b></p>     |   |

| Available Accessories | see page |
|-----------------------|----------|
| Power / Data MiniPort | 32       |
| Keyboard Tray         | 32       |
| Center Drawer         | 32       |

**EXAMPLE**

- ① 30 x 60 Double Pedestal Desk
- ② with One Drawer Glide Pedestal on Left,
- ③ Three Drawer Glide Pedestal on right and...
- ④ no Top Cutout and a Plain Modesty Panel

| MODEL NUMBER |          |           |          |
|--------------|----------|-----------|----------|
| Model Number | Left Ped | Right Ped | Options  |
| SZPD60       | - G1     | - G3      | - X - HM |

| PRODUCT PRICE |          |           |            |
|---------------|----------|-----------|------------|
| Base Price    | Left Ped | Right Ped | Options    |
| \$1,887       | + \$224  | + \$534   | + 0 + \$94 |

|                |
|----------------|
| <b>\$2,739</b> |
|----------------|

**WORKSHEET**

| MODEL NUMBER |          |           |         |
|--------------|----------|-----------|---------|
| Model Number | Left Ped | Right Ped | Options |
| _____        | - _____  | - _____   | - _____ |

| PRODUCT PRICE |          |           |         |
|---------------|----------|-----------|---------|
| Base Price    | Left Ped | Right Ped | Options |
| \$ _____      | + _____  | + _____   | + _____ |

|          |
|----------|
| \$ _____ |
|----------|

Please contact your ShuttleSystem dealer to obtain discounted project pricing.



## ◀ Techera Workstation

① CHOOSE FORMAT for base model number & price

② CHOOSE PEDESTAL

③ CHOOSE OPTIONS

Add pedestal and option codes to base Model Number and add accompanying prices to the base price.

| Orientation  | Standard                  |
|--|---------------------------|
| <b>Techera - Left</b><br>(no return / bookshelf)       | SZTDLXX<br><b>\$1,583</b> |
|  |                           |
| <b>Techera - Right</b><br>(no return / bookshelf)      | SZTDRXX<br><b>\$1,583</b> |
|  |                           |
| <b>TecheraPlus - Left</b><br>with return and bookshelf | SZTDLXR<br><b>\$2,665</b> |
|  |                           |
| <b>Techera - Right</b><br>with return and bookshelf    | SZTDRXR<br><b>\$2,665</b> |
|  |                           |

| Pedestal Style                                      |
|---|
| <b>-O</b><br>Open Shelves<br><b>N/C</b>             |
|   |
| <b>-D</b><br>Shelves with Door<br><b>\$153</b>      |
|   |
| <b>-1</b><br>One Shelf, One Drawer<br><b>\$224</b>  |
|   |
| <b>-S</b><br>One Shelf, Two Drawers<br><b>\$376</b> |
|   |
| <b>-2</b><br>Two File Drawers<br><b>\$444</b>       |
|   |
| <b>-3</b><br>Three Drawers<br><b>\$534</b>          |
|   |

| Top Cutout                                |
|---|
| <b>-G</b><br>One 3" Grommet<br><b>N/C</b> |
|   |
| <b>-E</b><br>MiniPort<br><b>\$294</b>     |
|   |

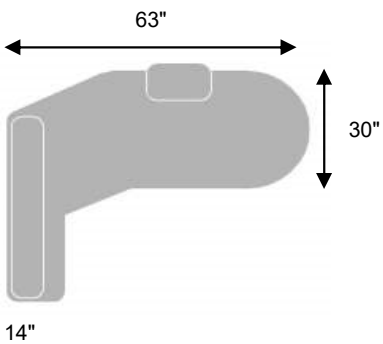

**Built-in Writing Trays:**

All supporting pedestals include space-saving pull-out writing trays

**Locks:**

Locks are standard on all drawers and doors.

**EXAMPLE**

- ① Techera Left, no return, no monitor well
- ② with Two File Drawer pedestal
- ③ and no top cutout

**MODEL NUMBER**

| Model Number | Pedestal | Top |
|--------------|----------|-----|
| SZTDLXX      | - 2 -    | X   |

**PRODUCT PRICE**

| Base Price  | Pedestal | Top |
|---|----------|-----|
| \$1,583   | + \$444  | + 0 |
| <div style="border: 1px solid black; display: inline-block; padding: 5px 20px;">\$2,027</div> |          |     |

**WORKSHEET**

**MODEL NUMBER**

| Model Number | Pedestal | Top |
|--------------|----------|-----|
| -            | -        | -   |

**PRODUCT PRICE**

| Base Price   | Pedestal | Top |
|--|----------|-----|
| \$   | +        | +   |
| <div style="border: 1px solid black; display: inline-block; padding: 5px 20px;">\$</div> |          |     |

*Please contact your ShuttleSystem dealer to obtain discounted project pricing.*

## ACCESSORIES

### Mobile Storage Pedestals

Mobile



2-Drawer (12"/12")  
2PED-18-M-12/12-L  
**\$891**

3-Drawer (6"/6"/12")  
3PED-18-M-6/6/12-L  
**\$940**

- > Sized to roll beneath 29" high desks
- > Dimensions 15" W x 19" D x 27" H
- > Locking Drawers

### Pencil Drawers

Basic Pencil Drawer

Basic  
ACC-PD-B  
**\$128**

Professional Pencil Drawer

ACC-PD-P  
**\$410**

### Book Boxes

Wire Book Box

Basic  
ACC-WB  
**\$50**

Molded Book Box

ACC-MB  
**\$50**

Metal Book Box

ACC-METAL BOOKBOX  
**\$0**

### Technology Accessories

Basic CPU Holder

ACC-CPUH-B  
**\$223**

Deluxe CPU Holder - Fixed

ACC-CPUH-DF  
**\$310**

Deluxe CPU Holder  
Slide-out / Swivel

ACC-CPUH-DS  
**\$431**

Keyboard Tray

ACC-K24  
**\$243**

MiniPort

ACC-MINIPOINT  
**\$294**

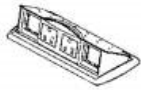

< For Techera Workstations and Desks with Pedestal Legs only

### Storage Totes

3" Tote

Basic  
ACC-T3  
**\$31**

6" Tote

ACC-T6  
**\$44**



# ShuttleZone Mobile Storage



Cabinets  
Wardrobes  
Workspace Storage  
Cubbies

ShuttleZone Mobile Storage is a smarter, more flexible solution for managing supplies, student belongings and classroom equipment.

Move storage easily within a room or relocate from room to room as your needs change.

- Robust construction with steel reinforcement
- Vertical and horizontal bumper protection
- Rugged PVC edging
- Premium, heavy-duty hardware throughout
- Heavy-duty casters
- Integral wire-management to accommodate technology and electronic equipment

## INDEX

### CATEGORY



### Mobile Storage Cabinets

**PAGE**

36 - 37

Choose from 96 formats:

- > Four heights; Extra-Tall 72", Tall 60", Low 36" or Extra-Low 29"
- > Three widths; 30", 36", or 42"
- > Three storage configurations (two heights); all shelves, shelves and drawers or all drawers
- > Two shelf styles; open or with locking doors

All formats include wire-management to accommodate electronic equipment.

### Mobile Wardrobes

38 - 39

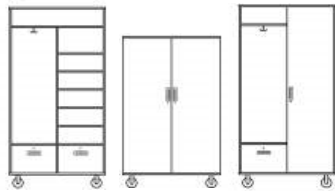

Choose from 96 formats:

- > Two heights; 72" or 60"
- > Three widths; 30", 36", or 42"
- > Three styles; open, single-door or double-door
- > Single File Drawer or Double File Drawer options

All formats include wire-management to accommodate electronic equipment.

### Mobile Workspace / Storage

40 - 41

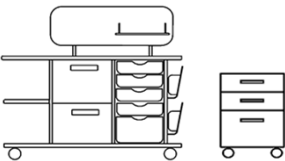

> Satellite Support Modules

> Mobile Storage Pedestals

### Mobile Cubbies

42

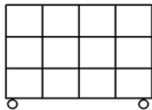

Four versatile formats; 30x36, 30x48, 36x36, 36x48

### Stationary Storage Cabinets

43

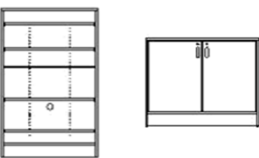

This supplementary offering of Stationary Cabinets is complementary to the Mobile Storage System but are designed for non-mobile (fixed) applications only.

Choose from 32 formats:

- > Four heights; Extra-Tall 72", Tall 60", Low 36" or Extra-Low 29"
- > Three widths; 30", 36", or 42"
- > Two styles; open or with locking doors

### Accessories

44

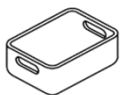

Storage Totes

### Shipping of ShuttleZone Mobile Storage

- > With the exception of loose components and accessories (adjustable shelves, totes, bins and organizer panels), all mobile cabinets, wardrobes, laptop carts, satellite support modules and latchable returns are shipped fully assembled.
- > Freight classification is 125.

# ShuttleZone Mobile Cabinets

## Cabinets | Extra-Tall - 72"







|         |   | Open Shelves   |                   |                   |                  | Shelves with Doors |                   |                   |                  |
|---------|---|----------------|-------------------|-------------------|------------------|--------------------|-------------------|-------------------|------------------|
| (24" D) |   |                |                   |                   |                  |                    |                   |                   |                  |
|         |   | No Drawers     | 5 Project Drawers | 3 Project Drawers | 1 Project Drawer | No Drawers         | 5 Project Drawers | 3 Project Drawers | 1 Project Drawer |
|         |   |                |                   | 1 File Drawer     | 2 File Drawers   |                    |                   | 1 File Drawer     | 2 File Drawers   |
|         |   | 5 Adj. Shelves | 3 Adj. Shelves    | 3 Adj. Shelves    | 3 Adj. Shelves   | 5 Adj. Shelves     | 3 Adj. Shelves    | 3 Adj. Shelves    | 3 Adj. Shelves   |
| Widths  |   | 1 Fixed Shelf  | 1 Fixed Shelf     | 1 Fixed Shelf     | 1 Fixed Shelf    | 1 Fixed Shelf      | 1 Fixed Shelf     | 1 Fixed Shelf     | 1 Fixed Shelf    |
| 30"     | SZMS-7230-XXXX;ZMS-7230-X14X;SZMS-7230-X121;SZMS-7230-X1X23 | <b>\$1,403</b> | <b>\$2,259</b>    | <b>\$2,152</b>    | <b>\$2,045</b>   | <b>\$1,759</b>     | <b>\$2,505</b>    | <b>\$2,398</b>    | <b>\$2,293</b>   |
| 36"     | SZMS-7236-XXXX;ZMS-7236-X14X;SZMS-7236-X121;SZMS-7236-X1X23 | <b>\$1,563</b> | <b>\$2,446</b>    | <b>\$2,334</b>    | <b>\$2,223</b>   | <b>\$1,924</b>     | <b>\$2,693</b>    | <b>\$2,581</b>    | <b>\$2,471</b>   |
| 42"     | SZMS-7242-XXXX;ZMS-7242-X14X;SZMS-7242-X121;SZMS-7242-X1X23 | <b>\$1,644</b> | <b>\$2,557</b>    | <b>\$2,453</b>    | <b>\$2,346</b>   | <b>\$2,055</b>     | <b>\$2,823</b>    | <b>\$2,718</b>    | <b>\$2,612</b>   |

## Cabinets | Tall - 60"



|         |   | Open Shelves   |                   |                   |                  | Shelves with Doors |                   |                   |                  |
|---------|---|----------------|-------------------|-------------------|------------------|--------------------|-------------------|-------------------|------------------|
| (24" D) |   |                |                   |                   |                  |                    |                   |                   |                  |
|         |   | No Drawers     | 5 Project Drawers | 3 Project Drawers | 1 Project Drawer | No Drawers         | 5 Project Drawers | 3 Project Drawers | 1 Project Drawer |
|         |   |                |                   | 1 File Drawer     | 2 File Drawers   |                    |                   | 1 File Drawer     | 2 File Drawers   |
|         |   | 4 Adj. Shelves | 2 Adj. Shelves    | 2 Adj. Shelves    | 2 Adj. Shelves   | 4 Adj. Shelves     | 2 Adj. Shelves    | 2 Adj. Shelves    | 2 Adj. Shelves   |
| Widths  |   | 1 Fixed Shelf  | 1 Fixed Shelf     | 1 Fixed Shelf     | 1 Fixed Shelf    | 1 Fixed Shelf      | 1 Fixed Shelf     | 1 Fixed Shelf     | 1 Fixed Shelf    |
| 30"     | SZMS-6030-XXXX;ZMS-6030-X14X;SZMS-6030-X121;SZMS-6030-X1X22 | <b>\$1,219</b> | <b>\$2,074</b>    | <b>\$1,969</b>    | <b>\$1,863</b>   | <b>\$1,548</b>     | <b>\$2,303</b>    | <b>\$2,196</b>    | <b>\$2,090</b>   |
| 36"     | SZMS-6036-XXXX;ZMS-6036-X14X;SZMS-6036-X121;SZMS-6036-X1X22 | <b>\$1,350</b> | <b>\$2,233</b>    | <b>\$2,122</b>    | <b>\$2,009</b>   | <b>\$1,683</b>     | <b>\$2,461</b>    | <b>\$2,351</b>    | <b>\$2,240</b>   |
| 42"     | SZMS-6042-XXXX;ZMS-6042-X14X;SZMS-6042-X121;SZMS-6042-X1X22 | <b>\$1,422</b> | <b>\$2,334</b>    | <b>\$2,229</b>    | <b>\$2,123</b>   | <b>\$1,793</b>     | <b>\$2,581</b>    | <b>\$2,475</b>    | <b>\$2,372</b>   |



### Cabinets | Low - 36"

|         | Shelves Only  |   | Shelves + Drawers   |   | Drawers Only  |   |   |
|---------|---|---|---|---|---|---|---|
| (24" D) |  |  |  |  |  |  |  |
|         | Open  | With Doors  | 2 Project Drawers   | 1 File Drawer   | 5 Project Drawers   | 3 Project Drawers<br>1 File Drawer  | 1 Project Drawer<br>2 File Drawers  |
|         | 2 Adj. Shelves  | 2 Adj. Shelves  | 1 Adj. Shelf  | 1 Adj. Shelf  |   |   |   |
| Widths  | SZMS-3630-XXXX;ZMS-3630-DXXX2   |   | SZMS-3630-XX2X1;ZMS-3630-XXX11  |   | SZMS-3630-X14X;SZMS-3630-X121X  |   | SZMS-3630-X1X2X   |
| 30"     | <b>\$916</b>  | <b>\$1,143</b>  | <b>\$1,237</b>  | <b>\$1,137</b>  | <b>\$1,719</b>  | <b>\$1,618</b>  | <b>\$1,519</b>  |
| 36"     | SZMS-3636-XXXX;ZMS-3636-DXXX2   |   | SZMS-3636-XX2X1;ZMS-3636-XXX11  |   | SZMS-3636-X14X;SZMS-3636-X121X  |   | SZMS-3636-X1X2X   |
|         | <b>\$991</b>  | <b>\$1,222</b>  | <b>\$1,321</b>  | <b>\$1,217</b>  | <b>\$1,818</b>  | <b>\$1,714</b>  | <b>\$1,610</b>  |
| 42"     | SZMS-3642-XXXX;ZMS-3642-DXXX2   |   | SZMS-3642-XX2X1;ZMS-3642-XXX11  |   | SZMS-3642-X14X;SZMS-3642-X121X  |   | SZMS-3642-X1X2X   |
|         | <b>\$1,030</b>  | <b>\$1,280</b>  | <b>\$1,370</b>  | <b>\$1,271</b>  | <b>\$1,885</b>  | <b>\$1,769</b>  | <b>\$1,687</b>  |

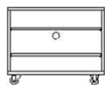
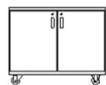
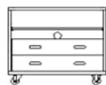
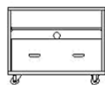
### Cabinets | Extra-Low - 29"

|         | Shelves Only  |   | Shelves + Drawers   |   | Drawers Only  |   |
|---------|---|---|---|---|---|---|
| (24" D) |  |  |  |  |  |  |
|         | Open  | With Doors  | 2 Drawers<br>(2 Project Drawer)   | 1 Drawer<br>(1 File Drawer)   | 4 Drawers<br>(4 Project)  | 3 Drawers<br>(2 Project / 1 File)   |
|         | 1 Adj. Shelf  | 1 Adj. Shelf  | 1 Adj. Shelf  | 1 Adj. Shelf  |   |   |
| Widths  | SZMS-2930-XXXX;ZMS-2930-DXXX1   |   | SZMS-2930-XX2X1;ZMS-2930-XXX11  |   | SZMS-2930-X13X;SZMS-2930-X111X  |   |
| 30"     | <b>\$778</b>  | <b>\$990</b>  | <b>\$1,099</b>  | <b>\$999</b>  | <b>\$1,421</b>  | <b>\$1,320</b>  |
| 36"     | SZMS-2936-XXXX;ZMS-2936-DXXX1   |   | SZMS-2936-XX2X1;ZMS-2936-XXX11  |   | SZMS-2936-X13X;SZMS-2936-X111X  |   |
|         | <b>\$864</b>  | <b>\$1,079</b>  | <b>\$1,192</b>  | <b>\$1,089</b>  | <b>\$1,523</b>  | <b>\$1,421</b>  |
| 42"     | SZMS-2942-XXXX;ZMS-2942-DXXX1   |   | SZMS-2942-XX2X1;ZMS-2942-XXX11  |   | SZMS-2942-X13X;SZMS-2942-X111X  |   |
|         | <b>\$908</b>  | <b>\$1,137</b>  | <b>\$1,247</b>  | <b>\$1,150</b>  | <b>\$1,590</b>  | <b>\$1,491</b>  |

# ShuttleZone Mobile Wardrobes

## Open Wardrobes | Extra-Tall 72"

|         | No Drawers                      | 1 File Drawer - Left            | 1 File Drawer - Right           | 2 File Drawers                  |
|---------|---------------------------------|---------------------------------|---------------------------------|---------------------------------|
| (24" D) |                                 |                                 |                                 |                                 |
| Widths  |                                 |                                 |                                 |                                 |
| 30"     | SZMW-7230-XX5<br><b>\$1,655</b> | SZMW-7230-XL5<br><b>\$1,862</b> | SZMW-7230-XR5<br><b>\$1,862</b> | SZMW-7230-X25<br><b>\$2,066</b> |
| 36"     | SZMW-7236-XX5<br><b>\$1,847</b> | SZMW-7236-XL5<br><b>\$2,071</b> | SZMW-7236-XR5<br><b>\$2,071</b> | SZMW-7236-X25<br><b>\$2,298</b> |
| 42"     | SZMW-7242-XX5<br><b>\$1,943</b> | SZMW-7242-XL5<br><b>\$2,169</b> | SZMW-7242-XR5<br><b>\$2,169</b> | SZMW-7242-X25<br><b>\$2,394</b> |

## Single-Door Wardrobes | Extra-Tall 72"

|         | No Drawers    |                                 | 1 File Drawer - Left |                                 | 1 File Drawer - Right |                                 | 2 File Drawers |                                 |
|---------|---------------|---------------------------------|----------------------|---------------------------------|-----------------------|---------------------------------|----------------|---------------------------------|
| (24" D) |               |                                 |                      |                                 |                       |                                 |                |                                 |
| Widths  | Left Door     | Right Door                      | Left Door            | Right Door                      | Left Door             | Right Door                      | Left Door      | Right Door                      |
| 30"     | SZMW-7230-LX5 | SZMW-7230-RX5<br><b>\$1,855</b> | SZMW-7230-LL5        | SZMW-7230-RL5<br><b>\$2,061</b> | SZMW-7230-LR5         | SZMW-7230-RR5<br><b>\$2,061</b> | SZMW-7230-L25  | SZMW-7230-R25<br><b>\$2,268</b> |
| 36"     | SZMW-7236-LX5 | SZMW-7236-RX5<br><b>\$2,050</b> | SZMW-7236-LL5        | SZMW-7236-RL5<br><b>\$2,276</b> | SZMW-7236-LR5         | SZMW-7236-RR5<br><b>\$2,276</b> | SZMW-7236-L25  | SZMW-7236-R25<br><b>\$2,502</b> |
| 42"     | SZMW-7242-LX5 | SZMW-7242-RX5<br><b>\$2,172</b> | SZMW-7242-LL5        | SZMW-7242-RL5<br><b>\$2,399</b> | SZMW-7242-LR5         | SZMW-7242-RR5<br><b>\$2,399</b> | SZMW-7242-L25  | SZMW-7242-R25<br><b>\$2,625</b> |

## Double-Door Wardrobes | Extra-Tall 72"

|         | No Drawers                      | 1 File Drawer - Left            | 1 File Drawer - Right           | 2 File Drawers                  |
|---------|---------------------------------|---------------------------------|---------------------------------|---------------------------------|
| (24" D) |                                 |                                 |                                 |                                 |
| Widths  |                                 |                                 |                                 |                                 |
| 30"     | SZMW-7230-2X5<br><b>\$2,058</b> | SZMW-7230-2L5<br><b>\$2,261</b> | SZMW-7230-2R5<br><b>\$2,261</b> | SZMW-7230-225<br><b>\$2,466</b> |
| 36"     | SZMW-7236-2X5<br><b>\$2,253</b> | SZMW-7236-2L5<br><b>\$2,479</b> | SZMW-7236-2R5<br><b>\$2,479</b> | SZMW-7236-225<br><b>\$2,705</b> |
| 42"     | SZMW-7242-2X5<br><b>\$2,403</b> | SZMW-7242-2L5<br><b>\$2,630</b> | SZMW-7242-2R5<br><b>\$2,630</b> | SZMW-7242-225<br><b>\$2,855</b> |

### Open Wardrobes | Tall 60"

|         | No Drawers                      | 1 File Drawer - Left            | 1 File Drawer - Right           | 2 File Drawers                  |
|---------|---------------------------------|---------------------------------|---------------------------------|---------------------------------|
| (24" D) |                                 |                                 |                                 |                                 |
| Widths  |                                 |                                 |                                 |                                 |
| 30"     | SZMW-6030-XX4<br><b>\$1,471</b> | SZMW-6030-XL4<br><b>\$1,683</b> | SZMW-6030-XR4<br><b>\$1,683</b> | SZMW-6030-X24<br><b>\$1,891</b> |
| 36"     | SZMW-6036-XX4<br><b>\$1,632</b> | SZMW-6036-XL4<br><b>\$1,862</b> | SZMW-6036-XR4<br><b>\$1,862</b> | SZMW-6036-X24<br><b>\$2,092</b> |
| 42"     | SZMW-6042-XX4<br><b>\$1,716</b> | SZMW-6042-XL4<br><b>\$1,948</b> | SZMW-6042-XR4<br><b>\$1,948</b> | SZMW-6042-X24<br><b>\$2,178</b> |

### Single-Door Wardrobes | Tall 60"

|         | No Drawers     |                | 1 File Drawer - Left |                | 1 File Drawer - Right |                | 2 File Drawers |                |
|---------|----------------|----------------|----------------------|----------------|-----------------------|----------------|----------------|----------------|
| (24" D) |                |                |                      |                |                       |                |                |                |
| Widths  | Left Door      | Right Door     | Left Door            | Right Door     | Left Door             | Right Door     | Left Door      | Right Door     |
| 30"     | SZMW-6030-LX   | SZMW-6030-RX4  | SZMW-6030-LL         | SZMW-6030-RL4  | SZMW-6030-LR          | SZMW-6030-RR4  | SZMW-6030-L24  | SZMW-6030-R24  |
|         | <b>\$1,661</b> | <b>\$1,661</b> | <b>\$1,872</b>       | <b>\$1,872</b> | <b>\$1,872</b>        | <b>\$1,872</b> | <b>\$2,081</b> | <b>\$2,081</b> |
| 36"     | SZMW-6036-LX   | SZMW-6036-RX4  | SZMW-6036-LL         | SZMW-6036-RL4  | SZMW-6036-LR          | SZMW-6036-RR4  | SZMW-6036-L24  | SZMW-6036-R24  |
|         | <b>\$1,820</b> | <b>\$1,820</b> | <b>\$2,050</b>       | <b>\$2,050</b> | <b>\$2,050</b>        | <b>\$2,050</b> | <b>\$2,281</b> | <b>\$2,281</b> |
| 42"     | SZMW-6042-LX   | SZMW-6042-RX4  | SZMW-6042-LL         | SZMW-6042-RL4  | SZMW-6042-LR          | SZMW-6042-RR4  | SZMW-6042-L24  | SZMW-6042-R24  |
|         | <b>\$1,930</b> | <b>\$1,930</b> | <b>\$2,161</b>       | <b>\$2,161</b> | <b>\$2,161</b>        | <b>\$2,161</b> | <b>\$2,392</b> | <b>\$2,392</b> |

### Double-Door Wardrobes | Tall 60"

|         | No Drawers                      | 1 File Drawer - Left            | 1 File Drawer - Right           | 2 File Drawers                  |
|---------|---------------------------------|---------------------------------|---------------------------------|---------------------------------|
| (24" D) |                                 |                                 |                                 |                                 |
| Widths  |                                 |                                 |                                 |                                 |
| 30"     | SZMW-6030-2X4<br><b>\$1,849</b> | SZMW-6030-2L4<br><b>\$2,060</b> | SZMW-6030-2R4<br><b>\$2,060</b> | SZMW-6030-224<br><b>\$2,269</b> |
| 36"     | SZMW-6036-2X4<br><b>\$2,010</b> | SZMW-6036-2L4<br><b>\$2,241</b> | SZMW-6036-2R4<br><b>\$2,241</b> | SZMW-6036-224<br><b>\$2,472</b> |
| 42"     | SZMW-6042-2X4<br><b>\$2,194</b> | SZMW-6042-2L4<br><b>\$2,374</b> | SZMW-6042-2R4<br><b>\$2,374</b> | SZMW-6042-224<br><b>\$2,606</b> |

# ShuttleZone Mobile Workspace / Storage



## ◁ OPEN SPACE MOBILE WORKSPACE/STORAGE

### Satellite Support Modules

**LOW - 29" (48" W x 24" D)**

**STANDARD CONFIGURATION**

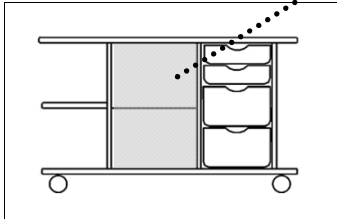

All Shelves in Shelf Bay  
4 Totes in Tote Bay

**SHELF BAY FORMATS**

| Standard       | 1 Drawer             | 2 Drawers                  | 3 Drawers                             |
|----------------|----------------------|----------------------------|---------------------------------------|
|                |                      |                            |                                       |
| Shelf<br>Shelf | Shelf<br>File Drawer | File Drawer<br>File Drawer | 6" Drawer<br>6" Drawer<br>File Drawer |

Add for Shelf Bay selection:

|                |            |              |              |              |
|----------------|------------|--------------|--------------|--------------|
| SZSSM-29       | -XX22      | -X122        | -X222        | -2122        |
| <b>\$1,458</b> | <b>\$0</b> | <b>\$222</b> | <b>\$441</b> | <b>\$528</b> |

**STORAGE ACCESSORIES**

Paper Trays

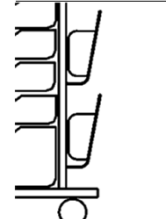

Two trays,  
vertical

Add for Storage Accessories:

|             |
|-------------|
| - 2         |
| <b>\$95</b> |

**TALL - 42" (48" W x 24" D)**

**STANDARD CONFIGURATION**

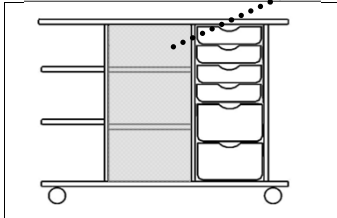

All Shelves in Shelf Bay  
6 Totes in Totes Bay

**SHELF BAY FORMATS**

| Standard                | 1 Drawer                      | 2 Drawers                           | 3 Drawers   | 4 Drawers  |
|-------------------------|-------------------------------|-------------------------------------|---|--|
|                         |                               |                                     |   |  |
| Shelf<br>Shelf<br>Shelf | Shelf<br>Shelf<br>File Drawer | Shelf<br>File Drawer<br>File Drawer | 6" Drawer<br>Half Shelf<br>File Drawer<br>File Drawer | 6" Drawer<br>6" Drawer<br>File Drawer<br>File Drawer |

Add for Shelf Bay selection:

|                |            |              |              |              |              |
|----------------|------------|--------------|--------------|--------------|--------------|
| SZSSM-42       | -XX42      | -X142        | -X242        | -1242        | -2242        |
| <b>\$2,149</b> | <b>\$0</b> | <b>\$222</b> | <b>\$441</b> | <b>\$594</b> | <b>\$746</b> |

**STORAGE ACCESSORIES**

Paper Trays

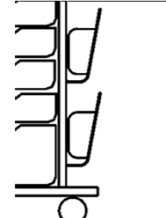

Three trays,  
vertical

Add for Storage Accessories:

|              |
|--------------|
| - 3          |
| <b>\$140</b> |

## Mobile Storage Pedestals

> Sized to roll beneath  
29" high ShuttleZone Desks

> Dimensions:  
15" W x 19" D x 27" H

> Locking Drawers

Two Drawers

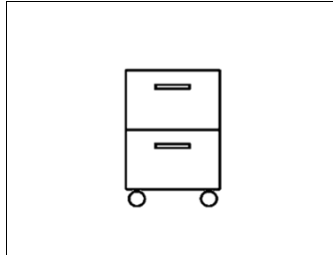

12" File  
12" File

2PED-18-M-12/12-L

**\$891**

Three Drawers



6" Drawer  
6" Drawer  
12" File





2PED-18-M-6/6/12-L

**\$940**

# ShuttleZone Mobile Cubbies

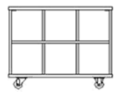
## Open Cubbies

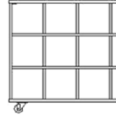
## Locking Cubbies

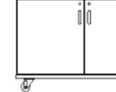
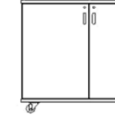
| 36" Wide<br>(20" D)  |   | 48" Wide<br>(20" D)   |   | 36" Wide<br>(20" D)   |  | 48" Wide<br>(20" D)   |   |
|--|---|---|---|---|--|---|---|
| 29" High   | 42" High  | 29" High  | 42" High  | 29" High  | 42" High   | 29" High  | 42" High  |
|  |  |  |  |  |  |  |  |
| SZMC-2936-X  | SZMC-4236-X   | SZMC-2948-X   | SZMC-4248-X   | SZMC-2936-D   | SZMC-4236-D  | SZMC-2948-D   | SZMC-4248-D   |
| <b>\$972</b>   | <b>\$1,189</b>  | <b>\$1,087</b>  | <b>\$1,304</b>  | <b>\$1,101</b>  | <b>\$1,342</b>   | <b>\$1,242</b>  | <b>\$1,491</b>  |

Interior dimensions of each individual cubby unit are nominally 11" W x 11" H x 12" D.

## 72" Extra -Tall Cabinets

Extra-Tall 72" cabinets include one fixed shelf and five adjustable shelves.

| 30" Wide<br>(16" D) |                | 36" Wide<br>(16" D) |                | 42" Wide<br>(16" D) |                |
|---------------------|----------------|---------------------|----------------|---------------------|----------------|
| Open                | With Doors     | Open                | With Doors     | Open                | With Doors     |
|                     |                |                     |                |                     |                |
| SZSS-7230-X5        | SZSS-7230-D5   | SZSS-7236-X5        | SZSS-7236-D5   | SZSS-7242-X5        | SZSS-7242-D5   |
| <b>\$903</b>        | <b>\$1,348</b> | <b>\$972</b>        | <b>\$1,422</b> | <b>\$1,040</b>      | <b>\$1,550</b> |

## 60" Tall Cabinets

Tall 60" cabinets include one one fixed shelf and four adjustable shelves.

| 30" Wide<br>(16" D) |                | 36" Wide<br>(16" D) |                | 42" Wide<br>(16" D) |                |
|---------------------|----------------|---------------------|----------------|---------------------|----------------|
| Open                | With Doors     | Open                | With Doors     | Open                | With Doors     |
|                     |                |                     |                |                     |                |
| SZSS-6030-X4        | SZSS-6030-D4   | SZSS-6036-X4        | SZSS-6036-D4   | SZSS-6042-X4        | SZSS-6042-D4   |
| <b>\$818</b>        | <b>\$1,229</b> | <b>\$872</b>        | <b>\$1,285</b> | <b>\$932</b>        | <b>\$1,396</b> |

## 36" Low Cabinets

Low 36" cabinets include three adjustable shelves.

| 30" Wide<br>(16" D) |              | 36" Wide<br>(16" D) |              | 42" Wide<br>(16" D) |                |
|---------------------|--------------|---------------------|--------------|---------------------|----------------|
| Open                | With Doors   | Open                | With Doors   | Open                | With Doors     |
|                     |              |                     |              |                     |                |
| SZSS-3630-X2        | SZSS-3630-D2 | SZSS-3636-X2        | SZSS-3636-D2 | SZSS-3642-X2        | SZSS-3642-D2   |
| <b>\$643</b>        | <b>\$949</b> | <b>\$678</b>        | <b>\$988</b> | <b>\$718</b>        | <b>\$1,050</b> |

## 29" Extra-Low Cabinets

Extra-Low 29" cabinets include two adjustable shelves

| 30" Wide     |              | 36" Wide     |              | 42" Wide     |              |
|--------------|--------------|--------------|--------------|--------------|--------------|
| Open         | With Doors   | Open         | With Doors   | Open         | With Doors   |
|              |              |              |              |              |              |
| SZSS-2930-X1 | SZSS-2930-D1 | SZSS-2936-X1 | SZSS-2936-D1 | SZSS-2942-X1 | SZSS-2942-D1 |
| <b>\$572</b> | <b>\$856</b> | <b>\$605</b> | <b>\$891</b> | <b>\$637</b> | <b>\$947</b> |

## Storage Totes

(12" W x 17" D)  
Use these handy totes to customize your ShuttleZone Mobile Storage and organize small items.

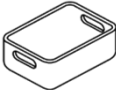
| 3" Tote   | 6" Tote   |
|---|---|
|  |  |
| ACC-T3  | ACC-T6  |
| <b>\$31</b>   | <b>\$44</b>   |





# ShuttleMate



## Changeable Computer Workstations



With all the strength and flexibility of our patented ShuttleSystem Changeable Computer Workstations but in a more streamlined design, ShuttleMate computer tables are perfect for less wire-intensive applications. Available in two standard depths and with sleek wire-management options, you can suit ShuttleMate to your school's specific technology needs.

- Optional top-loading wire trays to keep cords handy
- ShuttleLatch table connector for instant flexibility
- Ergonomic Pedestal Legs of rugged 14-gauge steel
- Strong metal-to-metal connections at stress points
- Friendly curved shapes enable collaborative learning

## INDEX

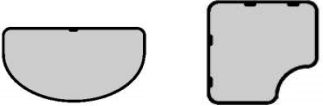
|  | <b>PAGE</b> |
|--|-------------|
|  Straight Profile | 48          |
|  Wave Profile     | 49          |
|  Other Shapes     | 50          |
| Accessories  | 51          |

---

### NOTES

ShuttleMate Worksurface Height: 22" to 32" adjustable leg is standard, available with either glides or casters.

ADA: For required 30" wide clearance, choose any of our standard 42" or wider stations.  
(Or to save classroom space, we offer a special-order 39" width at the same price as the 42".)

---

### Shipping of ShuttleMate Changeable Computer Tables

- > All orders of 10 stations and over will be bulk packed on pallets.
  - > Orders under 10 stations may be individually cartoned (large components may also be palletized).
  - > Freight classification is 70 for disassembled flat product.
-



## ◀ STRAIGHT PROFILE SHAPE 24"D / 30"D

### ① CHOOSE DEPTH

### ② CHOOSE GLIDES or CASTERS

### ③ ADD OPTION CODES and PRICES

| Profile                     | 24" D | 30" D |
|-----------------------------|-------|-------|
| <b>30" Straight Profile</b> |       |       |
| <b>36" Straight Profile</b> |       |       |
| <b>42" Straight Profile</b> |       |       |
| <b>48" Straight Profile</b> |       |       |
| <b>54" Straight Profile</b> |       |       |
| <b>60" Straight Profile</b> |       |       |
| <b>72" Straight Profile</b> |       |       |
| <b>Printer Station</b>      |       |       |

| Glides                        | Castors                       |
|-------------------------------|-------------------------------|
| SMH29G-2430ST<br><b>\$507</b> | SMH29C-2430ST<br><b>\$597</b> |
| SMH29G-3030ST<br><b>\$535</b> | SMH29C-3030ST<br><b>\$624</b> |
| SMH29G-2436ST<br><b>\$525</b> | SMH29C-2436ST<br><b>\$617</b> |
| SMH29G-3036ST<br><b>\$552</b> | SMH29C-3036ST<br><b>\$643</b> |
| SMH29G-2442ST<br><b>\$543</b> | SMH29C-2442ST<br><b>\$633</b> |
| SMH29G-3042ST<br><b>\$572</b> | SMH29C-3042ST<br><b>\$661</b> |
| SMH29G-2448ST<br><b>\$559</b> | SMH29C-2448ST<br><b>\$650</b> |
| SMH29G-3048ST<br><b>\$591</b> | SMH29C-3048ST<br><b>\$680</b> |
| SMH29G-2454ST<br><b>\$578</b> | SMH29C-2454ST<br><b>\$669</b> |
| SMH29G-3054ST<br><b>\$609</b> | SMH29C-3054ST<br><b>\$699</b> |
| SMH29G-2460ST<br><b>\$594</b> | SMH29C-2460ST<br><b>\$684</b> |
| SMH29G-3060ST<br><b>\$625</b> | SMH29C-3060ST<br><b>\$716</b> |
| SMH29G-2472ST<br><b>\$676</b> | SMH29C-2472ST<br><b>\$767</b> |
| SMH29G-3072ST<br><b>\$711</b> | SMH29C-3072ST<br><b>\$801</b> |
| SMH29G-2426PS<br><b>\$495</b> | SMH29C-2426PS<br><b>\$584</b> |
| SMH29G-3026PS<br><b>\$520</b> | SMH29C-3026PS<br><b>\$610</b> |

#### Add Option Codes and Prices

| Top Cutout                                | ShuttleLatch          | Raceway                |
|---|-----------------------|------------------------|
| -X<br>No cutout<br>N/C                    | -X<br>No Latch<br>N/C | -R<br><b>\$55</b>      |
|   |                       | -Flip*<br><b>\$101</b> |
|   |                       | -R<br><b>\$63</b>      |
|   |                       | -Flip*<br><b>\$112</b> |
| -E<br>MiniPort<br>(Standard Raceway Only) | -L<br>Shuttlelatch    | -R<br><b>\$72</b>      |
|   |                       | -Flip*<br><b>\$124</b> |
|   |                       | -R<br><b>\$81</b>      |
|   |                       | -Flip*<br><b>\$135</b> |
|   |                       | -R<br><b>\$90</b>      |
|   |                       | -Flip*<br><b>\$146</b> |
|   |                       | -R<br><b>\$98</b>      |
|   |                       | -Flip*<br><b>\$157</b> |
|   |                       | -R<br><b>\$117</b>     |
|   |                       | -Flip*<br><b>\$185</b> |
|   |                       | -R<br><b>\$55</b>      |
|   |                       | -Flip<br><b>N/A</b>    |







-FLIP option provides 4.5" flip-up panel on the back edge of the desktop for wide-opening access to wiring raceway.

\* Available on 30" deep stations



## ◁ WAVE PROFILE SHAPE 24"D / 30"D

### ① CHOOSE DEPTH



|   |       |
|---|-------|
| <b>30" Wave Profile</b>   | 24" D |
|    | 30" D |
| <b>36" Wave Profile</b>   | 24" D |
|    | 30" D |
| <b>42" Wave Profile</b>   | 24" D |
|    | 30" D |
| <b>48" Wave Profile</b>   | 24" D |
|    | 30" D |
| <b>54" Wave Profile</b>   | 24" D |
|    | 30" D |
| <b>60" Wave Profile</b>   | 24" D |
|  | 30" D |
| <b>72" Wave Profile</b>   | 24" D |
|  | 30" D |

### ② CHOOSE GLIDES or CASTERS

| Glides                        | Castors                       |
|-------------------------------|-------------------------------|
| SMH29G-2430WV<br><b>\$507</b> | SMH29C-2430WV<br><b>\$597</b> |
| SMH29G-3030WV<br><b>\$535</b> | SMH29C-3030WV<br><b>\$624</b> |
| SMH29G-2436WV<br><b>\$525</b> | SMH29C-2436WV<br><b>\$617</b> |
| SMH29G-3036WV<br><b>\$552</b> | SMH29C-3036WV<br><b>\$643</b> |
| SMH29G-2442WV<br><b>\$543</b> | SMH29C-2442WV<br><b>\$633</b> |
| SMH29G-3042WV<br><b>\$572</b> | SMH29C-3042WV<br><b>\$661</b> |
| SMH29G-2448WV<br><b>\$559</b> | SMH29C-2448WV<br><b>\$650</b> |
| SMH29G-3048WV<br><b>\$591</b> | SMH29C-3048WV<br><b>\$680</b> |
| SMH29G-2454WV<br><b>\$578</b> | SMH29C-2454WV<br><b>\$669</b> |
| SMH29G-3054WV<br><b>\$609</b> | SMH29C-3054WV<br><b>\$699</b> |
| SMH29G-2460WV<br><b>\$594</b> | SMH29C-2460WV<br><b>\$684</b> |
| SMH29G-3060WV<br><b>\$625</b> | SMH29C-3060WV<br><b>\$716</b> |
| SMH29G-2472WV<br><b>\$676</b> | SMH29C-2472WV<br><b>\$767</b> |
| SMH29G-3072WV<br><b>\$711</b> | SMH29C-3072WV<br><b>\$801</b> |

### ③ ADD OPTION CODES and PRICES

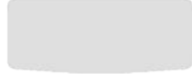
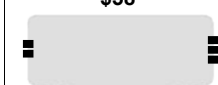
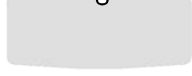
#### Add Option Codes and Prices



| Top Cutout  | ShuttleLatch   | Raceway  |
|---|--|--|
| -X<br>No cutout<br>N/C<br>                                    | -X<br>No Latch<br>N/C<br>             | -R<br><b>\$55</b><br>-Flip*<br><b>\$101</b><br>-R<br><b>\$63</b><br>-Flip*<br><b>\$112</b>   |
| -E<br>MiniPort<br>(Standard Raceway Only)<br><b>\$294</b><br> | -L<br>Shuttlelatch<br><b>\$58</b><br> | -R<br><b>\$72</b><br>-Flip*<br><b>\$124</b><br>-R<br><b>\$81</b><br>-Flip*<br><b>\$135</b>   |
|   |  | -R<br><b>\$90</b><br>-Flip*<br><b>\$146</b><br>-R<br><b>\$98</b><br>-Flip*<br><b>\$157</b><br>-R<br><b>\$117</b><br>-Flip*<br><b>\$185</b> |

-FLIP option provides 4.5" flip-up panel on the back edge of the desktop for wide-opening access to wiring raceway.

\* Available on 30" deep stations

## ROUNDED SHAPES and CORNER SHAPES

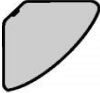

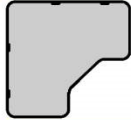
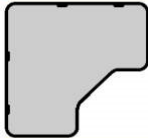

### ① CHOOSE SHAPE / DEPTH

|                           |       |  |
|---------------------------|-------|--|
| <b>Half Oval</b>          | 27" D |    |
|                           | 33" D |  |
| <b>Quarter Profile</b>    | 24" D |    |
|                           | 30" D |  |
| <b>42" Corner Profile</b> | 24" D |    |
|                           | 30" D |  |
| <b>48" Corner Profile</b> | 24" D |    |
|                           | 30" D |  |
| <b>60" Corner Profile</b> | 24" D |  |
|                           | 30" D |  |

### ② CHOOSE GLIDES or CASTERS

| Glides                          | Castors                         |
|---------------------------------|---------------------------------|
| SMH29G-2748HR<br><b>\$810</b>   | SMH29C-2748HR<br><b>\$946</b>   |
| SMH29G-3360HR<br><b>\$854</b>   | SMH29C-3360HR<br><b>\$989</b>   |
| SMH29G-2424QR<br><b>\$757</b>   | SMH29C-2424QR<br><b>\$847</b>   |
| SMH29G-3030QR<br><b>\$795</b>   | SMH29C-3030QR<br><b>\$886</b>   |
| SMH29G-2442CS<br><b>\$719</b>   | SMH29C-2442CS<br><b>\$855</b>   |
| SMH29G-3042CS<br><b>\$757</b>   | SMH29C-3042CS<br><b>\$891</b>   |
| SMH29G-2448CS<br><b>\$820</b>   | SMH29C-2448CS<br><b>\$955</b>   |
| SMH29G-3048CS<br><b>\$864</b>   | SMH29C-3048CS<br><b>\$1,000</b> |
| SMH29G-2460CS<br><b>\$1,017</b> | SMH29C-2460CS<br><b>\$1,154</b> |
| SMH29G-3060CS<br><b>\$1,072</b> | SMH29C-3060CS<br><b>\$1,208</b> |

### ③ ADD OPTION CODES and PRICES

| Add Option Codes and Prices  |  |                    |
|--|--|--------------------|
| Top Cutout   | ShuttleLatch   | Raceway            |
| -X<br>No cutout<br>N/C<br>         | -X<br>No Latch<br>N/C<br>             | -R<br><b>\$72</b>  |
| -E<br>MiniPort<br><b>\$294</b><br> | -L<br>Shuttlelatch<br><b>\$58</b><br> | -R<br><b>\$141</b> |
|  |  | -R<br><b>\$159</b> |
|  |  | -R<br><b>\$195</b> |

Flip Top Raceway not available on above Desk

**ShuttleMate****Changeable Computer Workstations****ACCESSORIES****Storage Pedestals**

Suspended

2-Drawer (12"/12")

2PED-18-S-12/12-L

**\$582**

Mobile

2PED-18-M-12/12-L

**\$891**

3-Drawer (6"/6"/12")

3PED-18-S-6/6/12-L

**\$809**

3PED-18-M-6/6/12-L

**\$940**

&gt; Dimensions 15" W x 18" D x 25" H

&gt; Locking Drawers

&gt; Dimensions 15" W x 19" D x 27" H

&gt; Locking Drawers

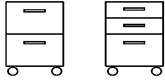
**Pencil Drawers**

Basic Pencil Drawer

Basic

ACC-PD-B

**\$128**

Professional Pencil Drawer

ACC-PD-P

**\$410****Technology Accessories**

Basic CPU Holder

ACC-CPUH-B

**\$223**

Deluxe CPU Holder - Fixed

ACC-CPUH-DF

Fixed

**\$310**

Deluxe CPU Holder

ACC-CPUH-DS

Slide-out / Swivel

**\$431**

Keyboard Tray

ACC-K24

**\$243**

MiniPort

ACC-MINIPOINT

**\$294****Electrical**

Electrical pricing is determined by workstation type, quantity and electrical requirements. Please call to receive a custom quotation for your project.

# ShuttleSystem

## Changeable Computer Workstations



Expertly designed for even heavily-wired computer equipment, ShuttleSystem's patented system of interlocking workstation shapes gives you all the flexibility of custom, built-in computer lab furniture but with instant flexibility. Rearrange your labs and media centers as quickly as technology and teaching methods change.

Fully-integrated wire raceway with handy flip-top access  
ShuttleLatch table connector for instant flexibility  
Recessed side panels for ample knee room  
Strong metal-to-metal connections at stress points  
Friendly curved shapes enable collaborative learning



# ShuttleSystem Changeable Computer Workstations







## INDEX

|   | PAGE            |
|---|-----------------|
|  | Workstations 54 |
|   | Accessories 55  |

### NOTES

ShuttleSystem Worksurface Height: 28" is standard, available with either glides or casters.  
Also available: 25" and 31" heights. Call for more information.

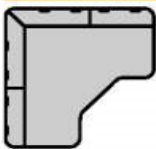
ADA: For required 30" wide clearance, choose any of our standard 42" or wider stations.  
(Or to save classroom space, we offer a special-order 39" width at the same price as the 42".)

|                 |   |  |   |
|-----------------|---|--|---|
| Wave Profile    |  | Straight Profile                                 |  |
| Quarter Profile |  | Single Printer Station<br>Double Printer Station |  |
| Corner Profile  |  | Corner Connector                                 |  |

### Shipping of ShuttleSystem Changeable Computer Furniture

- > All orders of 10 stations and over will be bulk packed on pallets.
- > Orders under 10 stations may be individually cartoned (large components may also be palletized).
- > Freight classification is 70 for disassembled flat product.



## ◁ WORKSTATIONS

|                                      | Non-Locking Raceway Covers                        |                                    | Locking Raceway Covers             |                                    |                                    |
|--------------------------------------|---|------------------------------------|------------------------------------|------------------------------------|------------------------------------|
|                                      | Glides  | Casters                            | Glides                             | Casters                            |                                    |
| <b>Wave Profile Workstations</b>     | 30" Wave Profile                                  | SS28G-3030WVX-ST<br><b>\$939</b>   | SS28C-3030WVX-ST<br><b>\$1,053</b> | SS28G-3030WVL-ST<br><b>\$1,014</b> | SS28C-3030WVL-ST<br><b>\$1,129</b> |
|                                      | 36" Wave Profile                                  | SS28G-3036WVX-ST<br><b>\$975</b>   | SS28C-3036WVX-ST<br><b>\$1,089</b> | SS28G-3036WVL-ST<br><b>\$1,050</b> | SS28C-3036WVL-ST<br><b>\$1,164</b> |
|                                      | 42" Wave Profile                                  | SS28G-3042WVX-ST<br><b>\$1,050</b> | SS28C-3042WVX-ST<br><b>\$1,164</b> | SS28G-3042WVL-ST<br><b>\$1,126</b> | SS28C-3042WVL-ST<br><b>\$1,241</b> |
|                                      | 48" Wave Profile                                  | SS28G-3048WVX-ST<br><b>\$1,126</b> | SS28C-3048WVX-ST<br><b>\$1,241</b> | SS28G-3048WVL-ST<br><b>\$1,276</b> | SS28C-3048WVL-ST<br><b>\$1,390</b> |
|                                      | 60" Wave Profile                                  | SS28G-3060WVX-ST<br><b>\$1,200</b> | SS28C-3060WVX-ST<br><b>\$1,314</b> | SS28G-3060WVL-ST<br><b>\$1,349</b> | SS28C-3060WVL-ST<br><b>\$1,464</b> |
|                                      | 72" Wave Profile                                  | SS28G-3072WVX-ST<br><b>\$1,499</b> | SS28C-3072WVX-ST<br><b>\$1,614</b> | SS28G-3072WVL-ST<br><b>\$1,648</b> | SS28C-3072WVL-ST<br><b>\$1,764</b> |
| <b>Straight Profile Workstations</b> | 30" Straight Profile                              | SS28G-3030STX-ST<br><b>\$939</b>   | SS28C-3030STX-ST<br><b>\$1,053</b> | SS28G-3030STL-ST<br><b>\$1,014</b> | SS28C-3030STL-ST<br><b>\$1,129</b> |
|                                      | 36" Straight Profile                              | SS28G-3036STX-ST<br><b>\$975</b>   | SS28C-3036STX-ST<br><b>\$1,089</b> | SS28G-3036STL-ST<br><b>\$1,050</b> | SS28C-3036STL-ST<br><b>\$1,164</b> |
|                                      | 42" Straight Profile                              | SS28G-3042STX-ST<br><b>\$1,050</b> | SS28C-3042STX-ST<br><b>\$1,164</b> | SS28G-3042STL-ST<br><b>\$1,126</b> | SS28C-3042STL-ST<br><b>\$1,241</b> |
|                                      | 48" Straight Profile                              | SS28G-3048STX-ST<br><b>\$1,126</b> | SS28C-3048STX-ST<br><b>\$1,241</b> | SS28G-3048STL-ST<br><b>\$1,276</b> | SS28C-3048STL-ST<br><b>\$1,390</b> |
|                                      | 60" Straight Profile                              | SS28G-3060STX-ST<br><b>\$1,200</b> | SS28C-3060STX-ST<br><b>\$1,314</b> | SS28G-3060STL-ST<br><b>\$1,349</b> | SS28C-3060STL-ST<br><b>\$1,464</b> |
|                                      | 72" Straight Profile                              | SS28G-3072STX-ST<br><b>\$1,499</b> | SS28C-3072STX-ST<br><b>\$1,614</b> | SS28G-3072STL-ST<br><b>\$1,648</b> | SS28C-3072STL-ST<br><b>\$1,764</b> |
| <b>Rounded</b>                       | Quarter Round Profile                             | SS28G-3030QRX-ST<br><b>\$1,239</b> | SS28C-3030QRX-ST<br><b>\$1,353</b> | SS28G-3030QRL-ST<br><b>\$1,314</b> | SS28C-3030QRL-ST<br><b>\$1,429</b> |
| <b>Corners</b>                       | Corner Profile                                    | SS28G-3048CSX-ST<br><b>\$2,435</b> | SS28C-3048CSX-ST<br><b>\$2,607</b> | SS28G-3048CSL-ST<br><b>\$2,735</b> | SS28C-3048CSL-ST<br><b>\$2,907</b> |
|                                      | Corner Connector                                  | SS28G-3042CSX-ST<br><b>\$1,239</b> | SS28C-3042CSX-ST<br><b>\$1,408</b> | SS28G-3042CSL-ST<br><b>\$1,388</b> | SS28C-3042CSL-ST<br><b>\$1,558</b> |
| <b>Storage Stations</b>              | Printer Station<br>(no storage pedestal)          | SS28G-3024STX-ST<br><b>\$900</b>   | SS28C-3024STX-ST<br><b>\$1,016</b> | SS28G-3024STL-ST<br><b>\$975</b>   | SS28C-3024STL-ST<br><b>\$1,089</b> |
|                                      | Printer Station<br>with 2-drawer storage pedestal | SS28G-3024PSX-ST<br><b>\$1,423</b> | SS28C-3024PSX-ST<br><b>\$1,539</b> | SS28G-3024PSL-ST<br><b>\$1,499</b> | SS28C-3024PSL-ST<br><b>\$1,614</b> |
|                                      | Double Storage Station                            | SS28G-3042DSX-ST<br><b>\$2,023</b> | SS28C-3042DSX-ST<br><b>\$2,137</b> | SS28G-3042DSL-ST<br><b>\$2,099</b> | SS28C-3042DSL-ST<br><b>\$2,214</b> |

# ShuttleSystem Changeable Computer Workstations

## ACCESSORIES

### Storage Pedestals

Suspended

2-Drawer (12"/12")

2PED-18-S-12/12-L

**\$582**

Mobile

2PED-18-M-12/12-L

**\$891**

3-Drawer (6"/6"/12")

3PED-18-S-6/6/12-L &gt; Dimensions 15" W x 18" D x 25" H

**\$809** > Locking Drawers

3PED-18-M-6/6/12-L &gt; Dimensions 15" W x 19" D x 27" H

**\$940** > Locking Drawers

### Pencil Drawers

Basic Pencil Drawer

Basic

ACC-PD-B

**\$128**

Professional Pencil Drawer

ACC-PD-P

**\$410**

### Technology Accessories

Basic CPU Holder

ACC-CPUH-B

**\$223**Deluxe CPU Holder - Fixed  
Fixed

ACC-CPUH-DF

**\$310**Deluxe CPU Holder  
Slide-out / Swivel

ACC-CPUH-DS

**\$431**

Keyboard Tray

ACC-K24

**\$243**

### Electrical

Electrical pricing is determined by workstation type, quantity and electrical requirements. Please call to receive a custom quotation for your project.

# Fixed Desks / Seating

## Tandem / Navetta Fixed Tables



Perfect for permanent and semi-permanent computer labs, Tandem's "semi-fixed" starter/adder design has all the structural integrity of built-in systems, yet it offers future reconfigurability.

Navetta fixed tables and seating provide the perfect solution for lecture rooms, auditoriums, and training rooms. Fixed seating solutions available in virtually any size and configuration.





Fully-integrated concealed wire-management channel  
Simple to install  
Economical  
Rugged designs with PVC edging, rugged steel tubing



# Fixed Desks

---

## INDEX

|                             |   |                                   | <b>PAGE</b> |
|-----------------------------|---|-----------------------------------|-------------|
| <b>TANDEM</b>               |  | Wave Profile                      | 58          |
|                             |  | Other Shapes                      | 58          |
|                             |  | Straight Profile                  | 59          |
| <b>ACCESSORIES</b>          |   |                                   | 62          |
| <hr/> <b>NAVETTA</b>        |   |                                   |             |
| <b>NAVETTA FIXED TABLES</b> |   | Symmetra / Omnia / Monolito       | 60          |
| <b>AUDITORIUM SEATING</b>   |   | Eidos/Premiere/S400 Contina/Capri | 61          |
| <b>LOOSE SEATING</b>        |   | Four legs, Task, Sled             | 62 - 63     |
| <b>OPTIONS</b>              |   | Other                             | 60-61       |

---

### NOTES

Tandem Worksurface Height: 28" is standard, available with glides.

ADA: For required 30" wide clearance, choose any of our standard 42" or wider stations.

(Or to save classroom space, we offer a special-order 39" width at the same price as the 42".)

---

### Shipping of Tandem Starter / Adder Computer Workstations

- > All orders of 10 stations and over will be bulk packed on pallets.
  - > Orders under 10 stations may be individually cartoned (large components may also be palletized).
  - > Weights are approximate and include shipping cartons.
  - > Freight classification is 70 for disassembled flat product.
-



**STANDARD SIZES**

|                              |                                    | Starter                          | Adder                            |
|------------------------------|------------------------------------|----------------------------------|----------------------------------|
|                              |                                    | 30" Wave Profile Workstation     | TA28S-S3030WVX-S<br><b>\$868</b> |
| 36" Wave Profile Workstation | TA28S-S3036WVX-S<br><b>\$916</b>   | TA28A-S3036WVX-S<br><b>\$719</b> |                                  |
| 48" Wave Profile Workstation | TA28S-S3048WVX-S<br><b>\$970</b>   | TA28A-S3048WVX-S<br><b>\$772</b> |                                  |
| 60" Wave Profile Workstation | TA28S-S3060WVX-S<br><b>\$1,025</b> | TA28A-S3060WVX-S<br><b>\$830</b> |                                  |
| 72" Wave Profile Workstation | TA28S-S3072WVX-S<br><b>\$1,188</b> | TA28A-S3072WVX-S<br><b>\$990</b> |                                  |
| Corner Connector - 45"       | TA28S-S3045CSX-S<br><b>\$1,138</b> |                                  |                                  |
| Printer Station              | TA28S-S3024PRX-S<br><b>\$820</b>   | TA28A-S3024PRX-S<br><b>\$623</b> |                                  |

|                              |                                    | 8" Raised Backs                    |       |
|------------------------------|------------------------------------|------------------------------------|-------|
|                              |                                    | Starter                            | Adder |
| 30" Wave Profile Workstation | TA28S-S3030WVX-M<br><b>\$909</b>   | TA28A-S3030WVX-M<br><b>\$711</b>   |       |
| 36" Wave Profile Workstation | TA28S-S3036WVX-M<br><b>\$968</b>   | TA28A-S3036WVX-M<br><b>\$771</b>   |       |
| 48" Wave Profile Workstation | TA28S-S3048WVX-M<br><b>\$1,034</b> | TA28A-S3048WVX-M<br><b>\$837</b>   |       |
| 60" Wave Profile Workstation | TA28S-S3060WVX-M<br><b>\$1,102</b> | TA28A-S3060WVX-M<br><b>\$907</b>   |       |
| 72" Wave Profile Workstation | TA28S-S3072WVX-M<br><b>\$1,282</b> | TA28A-S3072WVX-M<br><b>\$1,084</b> |       |
| Corner Connector - 45"       | TA28S-S3045CSX-M<br><b>\$1,245</b> |                                    |       |
| Printer Station              | TA28S-S3024PRX-M<br><b>\$860</b>   | TA28A-S3024PRX-M<br><b>\$662</b>   |       |

|                              |                                    | 18" Privacy Backs and Sides        |       |
|------------------------------|------------------------------------|------------------------------------|-------|
|                              |                                    | Starter                            | Adder |
| 30" Wave Profile Workstation | TA28S-H3030WVX-H<br><b>\$1,142</b> | TA28A-H3030WVX-H<br><b>\$824</b>   |       |
| 36" Wave Profile Workstation | TA28S-H3036WVX-H<br><b>\$1,169</b> | TA28A-H3036WVX-H<br><b>\$899</b>   |       |
| 48" Wave Profile Workstation | TA28S-H3048WVX-H<br><b>\$1,247</b> | TA28A-H3048WVX-H<br><b>\$976</b>   |       |
| 60" Wave Profile Workstation | TA28S-H3060WVX-H<br><b>\$1,329</b> | TA28A-H3060WVX-H<br><b>\$1,060</b> |       |
| 72" Wave Profile Workstation | TA28S-H3072WVX-H<br><b>\$1,521</b> | TA28A-H3072WVX-H<br><b>\$1,250</b> |       |
| Corner Connector - 45"       | TA28S-H3045CSX-H<br><b>\$1,513</b> |                                    |       |
| Printer Station              | TA28S-H3024PRX-H<br><b>\$1,049</b> | TA28A-H3024PRX-H<br><b>\$779</b>   |       |



## CUSTOM WIDTHS

|                               |   |
|-------------------------------|---|
| Straight Profile Workstations | 30" Straight Profile Workstation  |
|                               | 31" - 36" Straight Profile Workstation<br><i>enter width** in inches into code (i.e. 33S)</i> |
|                               | 37" - 48" Straight Profile Workstation<br><i>enter width** in inches into code (i.e. 40S)</i> |
|                               | 49" - 60" Straight Profile Workstation<br><i>enter width** in inches into code (i.e. 52S)</i> |
|                               | 61" - 72" Straight Profile Workstation<br><i>enter width** in inches into code (i.e. 64S)</i> |

| Standard Backs    |                  |
|-------------------|------------------|
| Starter           | Adder            |
| TA28S-S3030ST-X-S | TA28A-S3030STX-S |
| <b>\$868</b>      | <b>\$673</b>     |
| TA28S-S30**STX-S  | TA28A-S30**STX-S |
| <b>\$916</b>      | <b>\$719</b>     |
| TA28S-S30**STX-S  | TA28A-S30**STX-S |
| <b>\$970</b>      | <b>\$772</b>     |
| TA28S-S30**STX-S  | TA28A-S30**STX-S |
| <b>\$1,025</b>    | <b>\$830</b>     |
| TA28S-S30**STX-S  | TA28A-S30**STX-S |
| <b>\$1,188</b>    | <b>\$990</b>     |

|                               |   |
|-------------------------------|---|
| Straight Profile Workstations | 30" Straight Profile Workstation  |
|                               | 31" - 36" Straight Profile Workstation<br><i>enter width** in inches into code (i.e. 33S)</i> |
|                               | 37" - 48" Straight Profile Workstation<br><i>enter width** in inches into code (i.e. 40S)</i> |
|                               | 49" - 60" Straight Profile Workstation<br><i>enter width** in inches into code (i.e. 52S)</i> |
|                               | 61" - 72" Straight Profile Workstation<br><i>enter width** in inches into code (i.e. 64S)</i> |

| 8" Raised Backs   |                  |
|-------------------|------------------|
| Starter           | Adder            |
| TA28S-S3030ST-X-M | TA28A-S3030STX-M |
| <b>\$909</b>      | <b>\$711</b>     |
| TA28S-S30**STX-M  | TA28A-S30**STX-M |
| <b>\$968</b>      | <b>\$771</b>     |
| TA28S-S30**STX-M  | TA28A-S30**STX-M |
| <b>\$1,034</b>    | <b>\$837</b>     |
| TA28S-S30**STX-M  | TA28A-S30**STX-M |
| <b>\$1,102</b>    | <b>\$907</b>     |
| TA28S-S30**STX-M  | TA28A-S30**STX-M |
| <b>\$1,282</b>    | <b>\$1,084</b>   |

| 18" Privacy Backs and Sides |                  |
|-----------------------------|------------------|
| Starter                     | Adder            |
| TA28S-H3030ST-X-H           | TA28A-H3030STX-H |
| <b>\$1,142</b>              | <b>\$824</b>     |
| TA28S-H30**ST-X-H           | TA28A-H30**STX-H |
| <b>\$1,169</b>              | <b>\$899</b>     |
| TA28S-H30**ST-X-H           | TA28A-H30**STX-H |
| <b>\$1,247</b>              | <b>\$976</b>     |
| TA28S-H30**ST-X-H           | TA28A-H30**STX-H |
| <b>\$1,329</b>              | <b>\$1,060</b>   |
| TA28S-H30**ST-X-H           | TA28A-H30**STX-H |
| <b>\$1,521</b>              | <b>\$1,250</b>   |

# Fixed Tables

## STANDARD SIZES

|                                  |  |                 |                |
|----------------------------------|--|-----------------|----------------|
| Navetta Symmetra / Symmetra Plus | Symmetra (18" deep, per position)      | SYMM-S18        | <b>\$370</b>   |
|                                  | Straight Modesty Panel                 | MOD             | <b>\$165</b>   |
|                                  | Wire Mgmt - Power / Data               | WRMGMT          | <b>\$245</b>   |
|                                  | Symmetra Plus (18" deep, per position) |                 |                |
|                                  | w/Lovano, uphol seat, mesh back        | SYPL-S18-LOV-UM | <b>\$1,138</b> |
|                                  | Symmetra Plus (18" deep, per position) |                 |                |
|                                  | w/Avalon uphol seat, plastic back      | SYPL-S18-AVA-UP | <b>\$1,199</b> |
|                                  | w/Trilogy, uphol seat, poly back       |                 |                |
|                                  |  | SYPL-S18-TRI-P  | <b>\$890</b>   |
|                                  | w/Trilogy, uphol seat and back         |                 |                |
|                                  |  | SYPL-S18-TRI-U  | <b>\$980</b>   |
|                                  | w/Nortwood, uphol seat, wood back      |                 |                |
|                                  |  | SYPL-S18-UW     | <b>\$920</b>   |
|                                  | w/Nortwood, uphol seat and back        |                 |                |
|                                  |  | SYPL-S18-U      | <b>\$1,010</b> |
| w/Smart, uphol seat and back     |  |                 |                |
|                                  | SYPL-S18-SMA-U                         | <b>\$1,170</b>  |                |
| w/Zero7, uphol seat, poly back   |  |                 |                |
|                                  | SYPL-S18-007-UP                        | <b>\$1,270</b>  |                |
| w/Zero7, uphol seat and back     |  |                 |                |
|                                  | SYPL-S18-007-U                         | <b>\$1,350</b>  |                |
| w/Zero 7, uphol seat, mesh back  |  |                 |                |
|                                  | SYPL-S18-007-UM                        | <b>\$1,370</b>  |                |
| Straight Modesty Panel           |  |                 |                |
|                                  | MOD                                    | <b>\$165</b>    |                |
| Wire Mgmt - Power / Data         |  |                 |                |
|                                  | WRMGMT                                 | <b>\$245</b>    |                |

|                          |                                       |              |                |
|--------------------------|---------------------------------------|--------------|----------------|
| Navetta Monolito         | Monolito (18" deep, per position)     | MONO-S18     | <b>\$595</b>   |
|                          | Straight Modesty Panel                | MOD          | <b>\$165</b>   |
|                          | Wire Mgmt - Power / Data              | WRMGMT       | <b>\$245</b>   |
|                          | Monolito Plus (18" deep per position) |              |                |
|                          | w/Lovano                              | MONOP-S18    | <b>\$1,010</b> |
|                          | Straight Modesty Panel                |              |                |
|                          |                                       | MOD          | <b>\$165</b>   |
| Wire Mgmt - Power / Data |                                       |              |                |
|                          | WRMGMT                                | <b>\$245</b> |                |

|  |  |              |                |              |
|--|--|--------------|----------------|--------------|
| Navetta Omnia  | Omnia (per position)   | OMFL-S-W-FRT | OMFL-S-W-CEN   | OMFL-S-W-BAC |
|  | Flip-up table, beechwood seat perforated metal modesty panel   | <b>\$563</b> | <b>\$938</b>   | <b>\$574</b> |
|  | Flip-up table, upholstered seat perforated metal modesty panel | OMFL-S-U-FRT | OMFL-S-U-CEN   | OMFL-S-U-BAC |
|  |  | <b>\$604</b> | <b>\$1,007</b> | <b>\$616</b> |
|  | Fixed table, beechwood seat perforated metal modesty panel     | OMFX-S-W-FRT | OMFX-S-W-CEN   | OMFX-S-W-BAC |
|  |  | <b>\$500</b> | <b>\$833</b>   | <b>\$510</b> |
| Fixed table, upholstered seat perforated metal modesty panel | OMFX-S-U-FRT   | OMFX-S-U-CEN | OMFX-S-U-BAC   |              |
|  | <b>\$542</b>   | <b>\$903</b> | <b>\$553</b>   |              |

# Auditorium Seating

|                                 |             |                              |                               |                              |
|---------------------------------|-------------|------------------------------|-------------------------------|------------------------------|
| Eidos                           | upholstered | EID-STD-U<br><b>\$1,243</b>  | Ecoleather                    | EID-STD-EL<br><b>\$1,431</b> |
| Premiere                        | Ecoleather  | PRE-STD-EL<br><b>\$4,826</b> | Leather                       | PRE-STD-L<br><b>\$5,521</b>  |
| S400 Contina                    | upholstered | S4C-STD-U<br><b>\$370</b>    |                               |                              |
| Capri, Wood Back and End Panels | Ecoleather  | Capri<br><b>\$749</b>        | Capri Plus<br><b>\$846.00</b> |                              |
| Ventinove 9<br>Upholstered      | Upholsterd  | V9 -UP<br><b>\$1,130.00</b>  |                               |                              |
| Eco Leather                     | Ecoleather  | V9-ECO<br><b>\$1,124.00</b>  |                               |                              |
| Standard Tablet Option          |             | <b>\$204.00</b>              |                               |                              |

Navetta Auditorium Seating

# Navetta Loose Seating

|  | Five Star                         |                                  |                                    |                 |
|--|-----------------------------------|----------------------------------|------------------------------------|-----------------|
|  | Four leg                          | Task, Casters                    | Sled                               |                 |
| Avalon - No Arms                       |                                   |                                  |                                    |                 |
| Avalon uphol Seat, Poly Back           | AVALON4L-UP-X<br><b>\$400</b>     | AVALON5SB-UP-X<br><b>\$361</b>   |                                    |                 |
| Avalon uphol Seat, Mesh Back           | AVALON4L-UM-X<br><b>\$420.00</b>  | AVALON5SB-UM-X<br><b>\$380</b>   |                                    |                 |
| Avalon uphol Seat and Back             | AVALON4L-UU-X<br><b>\$423.00</b>  | AVALON5SB-UU-X<br><b>\$383</b>   |                                    |                 |
| Arms - Add                             | \$40                              | \$40                             |                                    |                 |
| Erica Poly Seat and Back               |                                   | ERICA-PP-4<br><b>\$194.00</b>    |                                    |                 |
| Erica Upholstered Seat, Poly Back      |                                   | ERICA-UP-4<br><b>\$227.00</b>    |                                    |                 |
| Eura, uphol seat, poly back            | EUR-1205-RNPNA9TP<br><b>\$643</b> |                                  | EUR-1205-SNNNA9TP<br><b>\$600</b>  |                 |
| Eura, uphol seat, mesh back            | EUR-1205-RNPNA9TR<br><b>\$770</b> |                                  | EUR-1205-SNNNA9TR<br><b>\$728</b>  |                 |
| Eura, uphol seat and back              | EUR-1205-RNPNA9TT<br><b>\$815</b> |                                  | EUR-1205-SNNNA9TT<br><b>\$773</b>  |                 |
| Lovano, uphol Seat, Mesh Back, Arms    |                                   | NVLO-XXX-A-B<br><b>\$390</b>     |                                    |                 |
| Lovano, uphol Seat, Mesh Back, No Arms |                                   | NVLO-XXX-X-B<br><b>\$350</b>     |                                    |                 |
| Matic Uphol Seat, Poly Back            |                                   | MATIC-UP<br><b>\$334</b>         |                                    |                 |
| Matic Uphol Seat, Mesh Back            |                                   | MATIC-UM<br><b>\$344</b>         |                                    |                 |
| Matic Uphol Seat and Back              |                                   | MATIC-PP<br><b>\$357</b>         |                                    |                 |
| Mya, upholstered                       | MYA-205-RNNNBN<br><b>\$1,663</b>  | MYA-205-BPXNNN<br><b>\$1,558</b> | MYA-205-CSNNNN-D<br><b>\$1,870</b> |                 |
| Nortwood, uphol seat, beechwood back   | NOR-4DSK-UW<br><b>\$440</b>       | NOR-5TSK-UW<br><b>\$470</b>      |                                    |                 |
| Nortwood, uphol seat and back          | NOR-4DSK-U<br><b>\$470</b>        | NOR-5TSK-U<br><b>\$500</b>       |                                    |                 |
| Teorama                                | TEO-3501-R1PNGN                   | TEO-3501-R2PNGN                  | TEO-3501-R3PNGN                    | TEO-3501-R4PNGN |
| Unit = Single, 2, 3 or 4 Seats         | <b>\$1,420</b>                    | <b>\$2,372</b>                   | <b>\$3,300</b>                     | <b>\$4,535</b>  |

Navetta Loose Seating

|                                     | Four leg                          | Task                              | Sled                       |
|-------------------------------------|-----------------------------------|-----------------------------------|----------------------------|
| Smart, upholstered seat and back    | SMA-2711-RNNNAN<br><b>\$533</b>   | SMA-2716-MAXND8<br><b>\$835</b>   |                            |
| Trilogy, uphol seat, poly back      | TRI-4DSK-P<br><b>\$370</b>        | TRI-5TSK-P<br><b>\$400</b>        |                            |
| Trilogy, upholstered seat and back  | TRI-4DSK-U<br><b>\$460</b>        | TRI-5TSK-U<br><b>\$490</b>        |                            |
| Verona Poly seat and back           | Verona-4L-PP<br><b>\$410</b>      | Verona-5SBL-PP<br><b>\$386</b>    |                            |
| Verona Uphol Seat and Poly Back     | Verona-4L-UP<br><b>\$545</b>      | Verona-5SBL-UP<br><b>\$581</b>    |                            |
| Verona Uphol Seat and Back          | Verona-4L-UU<br><b>\$660</b>      | Verona-5SBL-PP<br><b>\$658</b>    |                            |
| Woody, beech wood                   | WDY-505-RNNNAE-W<br><b>\$610</b>  | WDY-501-BAXNNN-W<br><b>\$485</b>  |                            |
| Woody, uphol seat and back          | WDY-505-RNNNAE-U<br><b>\$693</b>  | WDY-501-BAXNNN-U<br><b>\$568</b>  |                            |
| Woody, full leather                 | WDY-505-RNNNAE-L<br><b>\$965</b>  | WDY-501-BAXNNN-L<br><b>\$840</b>  |                            |
| Zero 7, uphol seat with poly back   | 007-7231-RNNBANTP<br><b>\$643</b> | 007-7231-MAXBNNTP<br><b>\$770</b> |                            |
| Zero 7, uphol seat with mesh back   | 007-7231-RNNNANTR<br><b>\$725</b> | 007-7231-MAXBNNTR<br><b>\$848</b> |                            |
| Zero 7, uphol seat and back         | 007-7231-RNNBANTT<br><b>\$743</b> | 007-7231-MAXBNNTT<br><b>\$865</b> |                            |
|                                     | (with folding, stackable base)    |                                   |                            |
| Zero 9, poly seat and back          | 80A1-RNPN1N PP<br><b>\$490</b>    | Options for Zero 9 >>>            | casters<br><b>\$33</b>     |
| Zero 9, upholstered seat, poly back | 80A1-RNPN1N TP<br><b>\$550</b>    |                                   | arms<br><b>\$72</b>        |
| Zero 9, upholstered seat and back   | 80A1-RNPN1N TT<br><b>\$610</b>    |                                   | Tablet arm<br><b>\$235</b> |

Navetta Loose Seating

## ACCESSORIES

### Storage Pedestals

Suspended

2-Drawer (12"/12")  
2PED-18-S-12/12-L

**\$582**

3-Drawer (6"/6"/12")  
3PED-18-S-6/6/12-L

**\$809**

> Dimensions 15" W x 18" D x 25" H

> Locking Drawers

Mobile

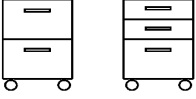

2PED-18-M-12/12-L  
**\$891**

3PED-18-M-6/6/12-L  
**\$940**

> Dimensions 15" W x 19" D x 27" H

> Locking Drawers

### Pencil Drawers

Basic Pencil Drawer

Basic

ACC-PD-B

**\$128**

Professional Pencil Drawer

ACC-PD-P

**\$410**

### Technology Accessories

Basic CPU Holder

ACC-CPUH-B

**\$223**

Deluxe CPU Holder - Fixed  
Fixed

ACC-CPUH-DF

**\$310**

Deluxe CPU Holder  
Slide-out / Swivel

ACC-CPUH-DS

**\$431**

Keyboard Tray

ACC-K24

**\$243**

### Electrical

Electrical pricing is determined by workstation type, quantity and electrical requirements. Please call to receive a custom quotation for your project.

# ShuttleSystem

## Pricing, Policy, Terms & Conditions of Sale

---

---

**Pricing**

All prices are F.O.B. factory at Mt. Vernon, Washington.  
All prices and specifications are subject to change without notice.  
All prices are for standard finishes only. Please call for pricing on custom finishes.

---

**Packaging**

All orders of 10 stations and over will be bulk packed on pallets. Orders under 10 stations may be individually cartoned (large components may also be palletized).

---

**Shipping**

All shipments are F.O.B. origin at Mt. Vernon, Washington.

---

**Freight Claims**

By FTC law, title to merchandise passes to addressee upon acceptance by carrier. Addressee is solely responsible for inspection or shipment before acceptance of delivery from carrier, and for filing any claims for shortage or damage with carrier. Notification of concealed damage must be made to carrier within 15 days after delivery; carrier responsibility ceases after 15 days.

---

**Product Design**

ShuttleSystem maintains the right to introduce design changes any time without notice. All dimensions are nominal. Worksurface dimensions based on rectangular material blank size. Colors will vary from printed literature, we recommend viewing physical samples of colors before finalizing order.

---

**Warranty**

All K-12 products are guaranteed against defective material and workmanship for a period of 15 years from date of actual receipt by the user, except optional gas strut mechanisms guaranteed for 5 years. Fixed tables (Symmetra, Symmetra Plus, Omnia, and Monolito) are guaranteed as follows: Structural components 10 yrs, other structural components 5 years, plastic, paint, wood, laminate and other surface finishes 3 years, power and electrical components, seating upholstery 1 year. Warranty does not apply to any product which has been altered or modified from the original design or specification or to any product damage resulting from accidents, negligence or shipping.



SHUTTLESYSTEM LLC  
7697 Innovation Way,  
Suite 400,  
Mason, OH 45040  
800.411.1979

[Shuttlefurniture.com](http://Shuttlefurniture.com)

© Shuttle Furniture 2018 Product details subject to change without notice.